

WIRED

250+ PRODUCTS TESTED AND RATED

FIND THE RIGHT:

- Digital Cameras
- Laptops
- Phonecams
- Plasma TVs
- Video Cameras
- Wireless Keyboards
- Photo Printers
- MP3 Players
- Surround Sound Systems
- Movies-On-Demand
- Tablet PCs
- Online Music Services
- Media Streamers
- Coffeemakers
- Gaming Accessories

PLUS: Home theater gear you can afford

From the
Editors of
WIRED
America's Premier
Tech Magazine

**THE ULTIMATE
BUYER'S GUIDE
TO THE BEST
PRODUCTS**



DISPLAY UNTIL FEBRUARY 9, 2005

TEST

WIRED

THE ULTIMATE BUYER'S GUIDE TO THE BEST PRODUCTS

CONTENTS

14 Surviving the Gizmo Explosion

Relax: We tested hundreds of products so you don't have to. **by Chris Anderson**

PLUS: A sneak preview of 7 cool technologies of tomorrow.

PLUS: The top 10 reviews from *Wired's* Gadget Lab newsletter.



COMMUNICATION

23 Mobile Phones

Multifunction phones, megapixel phonecams, and phone-PDA hybrids

32 Scorecard

PLUS: Internet phone services



CAMERAS

35 Digital Cameras

Pocket-sized, full-featured compact, and digital SLR cameras

43 Scorecard

PLUS: Photo printers

47 Digital Video Cameras

MiniDV and tapeless video cameras

52 Scorecard



VIDEO

55 High-Definition TVs

Plasma, LCD, and rear-projection TVs, and high-end projectors

63 Scorecard

PLUS: Budget projectors & widescreen PC monitors

69 Digital Video Recorders

High-definition, standard-definition, and DVD-burning DVRs

75 Scorecard

PLUS: DVD rental by mail & movies-on-demand



RED COVER: Sanyo XactiVPC-C1 pocket camcorder, © PSC/T3 Magazine. Find the US version, Sanyo Fisher FVD-C1, on page 52.
BLUE COVER: Panasonic D-Snap SV-AV50A tapeless camcorder, Craig Maxwell. Find it on page 52.

CONTENTS



AUDIO

79 MP3 Players

20-gig hard drive, microdrive, and flash-memory players

86 Scorecard

PLUS: Portable speakers & online music stores

93 Home Theater Gear

6.1 surround systems, autocalibrating receivers, 12-inch subwoofers, and virtual surround systems

100 Scorecard

PLUS: High-end clock radios

103 Headphones

Hi-fi, surround sound, in-ear, and noise-canceling headphones

108 Scorecard



HOUSEHOLD

113 Kitchen and Bath

Super-automatic coffee machines, ceramic chef's knives, oven mitts and gloves, and shower TVs and radios

119 Scorecard

PLUS: Robotic vacuums



COMPUTING & GAMING

123 Laptops

Thin-and-light laptops, tablet PCs, and multimedia, gaming, and ruggedized laptops

131 Scorecard

PLUS: Programmable robot kits

133 Specialty PCs

Gaming and Media Center PCs

137 Scorecard

PLUS: Wireless desktop sets & USB gadgets

140 Gaming Accessories

Speaker systems, wireless controllers, and specialty gear

146 Scorecard

PLUS: Karaoke mikes

148 Media Streamers

Audio and audio/video streamers

153 Scorecard

154 Pop Quiz

WIRED TEST

EDITOR IN CHIEF CHRIS ANDERSON

ISSUE EDITOR ROBERT CAPPS WIRED TEST EDITOR SEAN CAPTAIN WIRED TEST DEPUTY EDITORS SEAN COOPER, JON J. EILENBERG

ART DIRECTOR DONALD NGAI DESIGNER ALLISTER FEIN PHOTO EDITOR ZANA WOODS

RESEARCH EDITOR ERIK MALINOWSKI ASSOCIATE EDITOR BRIAN LAM

PHOTO PRODUCERS AMY GRILLY, LEE DECKER PHOTO ASSOCIATE ANNA ALEXANDER

CONTRIBUTING DESIGNER RONALD CHOE CONTRIBUTING PHOTO CLERKS JOHN FEENEY, MORIAH ZAGAGLIA

CONTRIBUTING RESEARCH EDITORS DAVID DOWNS, CATHERINE HOWARD, MELISSA MILLER, ELIZABETH SVOBODA

ILLUSTRATOR PJ RICHARDSON PHOTOGRAPHER CRAIG MAXWELL PHOTO ASSISTANT BECKIE MORLEY

STYLIST MICAH BISHOP/ARTIST UNTIED STYLIST ASSISTANT BORY TAN/ARTIST UNTIED



EDITOR IN CHIEF CHRIS ANDERSON



Executive Editor Bob Cohn
Managing Editor Blaise Zerega
Articles Editor Thomas Goetz
Deputy Editor William O. Goggins

Creative Director Darrin Perry
Director of Photography Brenna Britton
Design Director Federico Gutiérrez-Schott
Photo Editor Zana Woods

Assistant Managing Editor Rebecca Smith Hurd
Senior Editors Adam Fisher, Ted Greenwald,
Jennifer Hillner, Laura Moorhead,
Susan Murcko, Jeffrey M. O'Brien, Mark Robinson

Art Directors Donald Ngai, Mark Wasyl
Designer Allister Fein
Design Assistant Lee Decker
Contributing Designer Ronald Choe

Products Editor Robert Capps

Senior Associate Editor Adam Rogers

Assistant Editors Chris Baker, Eric Steuer

Copy Chief Jennifer Prior

Copy Editors Jon J. Eilenberg, Pennie Rossini

Research Editor Joanna Pearlstein

Assistant Research Editors Kari Lynn Dean,
Greta Lorge, Erik Malinowski

Editorial Assistant Brian Lam

Editorial Business Manager Erica Jewell

Assistant to the Editor in Chief Peter Arcuni

Deputy Photo Editor Carolyn Rauch

Photo Producer Jennifer McKibben

Photo Associate Anna Alexander

Photo Assistant Lauren Winfield

Photo Production Assistant Ezra Eismont

Photo Clerks Kate Webber, Amy Crilly

Production Director Michael Lee

Associate Production Director Jeff Lysgaard

Associate Production Manager Jay Dayrit

Editorial Projects Director Melanie Cornwell

Editor at Large Kevin Kelly

Interns David Goldenberg (Reporting),
Ryan Sommer (Products),
Erika Stalder (Research), Terry Tang (Edit)



SURVIVING THE GIZMO EXPLOSION

Relax: We tested hundreds of products so you don't have to.

The last computer any one person could completely understand from top to bottom, software to hardware, was the Data General Eclipse MV, the subject of Tracy Kidder's 1981 best seller, *The Soul of a New Machine*. Kidder's story set the stage for the day when the complexity of a machine would exceed the grasp of even its savviest users. This quickly came to pass with computing, and about the same time, it happened with cars. The combination of fuel injection and advances like electronic antilock brakes put the average automobile beyond the ken of the individual mechanic. And now, in a similar way, it's happening to me.

The madness began innocently enough: I subscribed to Rhapsody, the streaming-music service that offers access to more than 700,000 songs for \$10 a month. Suddenly, it was all music, all the time – but only through my PC's speakers. If only there were some way to broadcast it throughout the entire house ...

There were solutions, of course, dozens of them. And I tried them all. From pre-802.11 wireless devices to modern media streamers to really long cables – each yielding its own lessons in interference, RF signals, and carpentry.

And so it went: By the time I got to the networked Xbox and the universal remote, I felt like I needed a PhD in setup and installation. Then, charmed by an LCD projector, I pursued a full home theater – but only after a yearlong (and ultimately fruitless) search for an audio option that didn't require a half-dozen speakers littering the living room. And deciding to go for a proper 6.1 system only led me down the audiophile rabbit hole, where the questions

became practically metaphysical once I started looking for answers. (Are *your* speakers voice matched?)

These days, my early experiences seem to hold true for every category of consumer electronics I dive into, from DV cams to laptops. I've now tested more devices in more variations than I care to recall. I've learned a lot, but in each case, making the right decision required hours of research, with no small amount of money wasted on missteps.

Yet this is the golden age of gadgets. There are unprecedented choices, innovations, and features, all at rapidly falling prices. And along with the explosion of digital media, home theater, and pocket gear has come equally unprecedented complexity and risk. It's too hard to know what to buy – and that starts with a dearth of solid, trustworthy advice and hands-on experience. Amazon.com user opinions are great, but they shouldn't be all there is to go on.

Enter *Wired Test*. Throughout the year, we publish hundreds of consumer electronics reviews in our magazine and weekly email newsletter, Gadget Lab – not just first impressions or feature summaries, but hands-on, real-world, head-to-head evaluations, with winners, losers, and everything in between. But in an era when product cycles are measured in months, even that's not enough. So we poked and prodded a few hundred more gizmos, picked the latest and greatest, and pulled them all together into a comprehensive guide to buying smart: the best gear, the best values, and dozens of tips on finding what's right for you. The day when no mortal can fully understand the digital lifestyle has been delayed. Let sanity reign. – **Chris Anderson**

Choosing and Testing the Best Gear



To create *Wired Test*, we waded through nearly a thousand products and selected the coolest in more than a dozen categories. We tested each gadget under real-world conditions, and rated it, based on performance and value, on a zero-to-five scale.

Tech of Tomorrow

Gadget lust takes many forms. There's the panting need to buy that just-released MP3 player. Or the nostalgic yearning to collect, say, vintage Atari 2600 consoles. Then there's the jones for technologies just over the horizon. Here are 7 inventions still on the drawing board. **by Brendan I. Koerner**

◀ METHANOL FUEL CELL

Ask 100 iPod owners to gripe about the gadget, and 95 of them will mention the paltry battery life. Lithium-ion batteries – the industry staple – may be lightweight, but they skimp on power. Toshiba's solution is a 0.3-ounce methanol fuel cell, which can power a hard disk MP3 player for up to 20 hours. Although Toshiba expects to bring the cells to market in 2005, the company is still uncertain how consumers will refill the battery once it's empty. A rather cumbersome possibility: fueling stations in consumer electronics stores.

◀ WIMAX

WiMax – a Wi-Fi alternative with a range of up to 30 miles – is rolling out in early 2005. But the first wave will be aimed at bringing broadband to fixed locations like homes and offices. The real fun will start in 2006, when chipsets for mobile devices hit the market. Although Intel will lead the way with laptop-ready hardware, the company is not revealing much, such as whether its chipset will be compatible with 802.16a (for stationary users), 802.16d (for pedestrians), or 802.16e (for motorists). But remember: Friends don't let friends surf and drive.

◀ VOICE-RECOGNITION CARDS

Despite all those cute Citibank commercials trumpeting newfangled fraud protections, identity theft remains a major concern for consumers. Foolproof help may be on the way – a credit card equipped with voice-recognition technology. A prototype from Beepcard in Santa Monica, California, asks users to say a password into a tiny on-card microphone. If the user's voice doesn't match a sample stored in the card's voice-recognition chip, the transaction isn't authorized. But the latest version is three times thicker than a conventional card, owing largely to the size of Beepcard's chip. Once that's solved, life could get a whole lot tougher for crooks – unless they happen to be master impressionists, too.



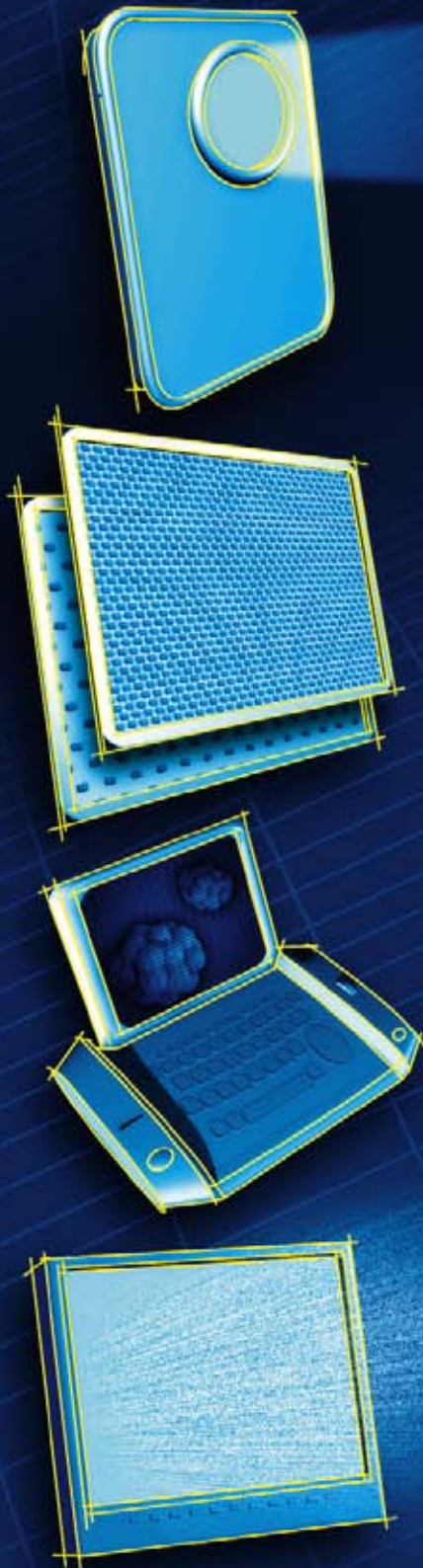

◀ PHOTON VACUUM PROJECTOR

Finland's Upstream Engineering hasn't quite determined the first application for its postage stamp-sized video projector, but there are certainly plenty of possibilities. The Photon Vacuum Projector would be perfect for everyday devices like phonecams, allowing users to beam their snapshots onto 20-inch screens. Or you could put one on a PDA equipped with PowerPoint to eliminate the need for bulky tabletop projectors. Upstream's prototype relies on proprietary technology that pulls light particles out of an LED and makes the projector far more efficient than its larger predecessors. The company hopes within a few years to manufacture a projector that draws just 4 watts of power while still providing a crisp video image.

◀ ULTRA HIGH DEFINITION VIDEO

HDTV is just starting to shine, and already video researchers are moving on to the Next Big Thing. Engineers at the Japan Broadcasting Corporation (NHK) have developed a camera-and-projection system, Ultra High Definition Video, that produces images with 16 times more pixels than anything now on the market. The heart of the system is a projector that uses four liquid-crystal-on-silicon imaging chips. But UHDV is incredibly memory-hungry: NHK's researchers burned through 3.5 terabytes to capture just 18 minutes of footage. Evidently, that's more than enough to wow viewers – those who've checked it out report that the images are indistinguishable from reality. At one demo, featuring a driver's-eye view from a car, several attendees got nauseated from the realism.

◀ VARIATIONAL SHAPE APPROXIMATION

Even the best cell phone games look no better than an Atari 2600 title, circa 1982. The conventional wisdom is that mobile gadgets simply don't have the power to render the kind of gorgeous 3-D images that gamers experience on a PC. But a pair of Caltech professors are disproving that notion with an ingenious compression algorithm, dubbed variational shape approximation. Mathieu Desbrun and Peter Schröder have figured out a way to replicate an intricate 3-D file that takes up only a fraction of the memory of the original. The first application, says Desbrun, will likely be medical, allowing doctors to view MRIs on pocket PCs as they make their rounds. But the masses will no doubt be more interested in playing a reasonable facsimile of *Doom 3* on their Sidekicks.

◀ FIELD EMISSION DISPLAY

Flat-panel TVs have their obvious advantages, but image quality isn't one of them. Old-fashioned CRTs, despite their bulk, still produce far superior pictures. But that's set to change as researchers at Samsung and elsewhere fine-tune their work on field emission displays composed of carbon nanotubes. Unlike CRTs, which rely on a single electron gun to sweep across the inside of a picture tube, FEDs contain millions of miniaturized guns, one behind each phosphor pixel. FED technology has been kicking around for decades, but it's not until recently that Samsung engineers were able to push the approach beyond the theoretical. The company is reportedly close to producing a 30-inch FED prototype that'll likely rival the best plasma and LCD screens for thinness – and still produce as rich a picture as the best tube TVs can.

THE BEST OF

GADGET LAB

The Top 10 Reviews From Our Weekly Email Blast

Mmmmm. Smell that? It's the latest shipment of fresh, piping-hot consumer electronics. Every day we scamper to meet the FedEx dude who inundates the *Wired* offices with samples and review units of all the newest tech. We pull out our stopwatch, tweezers, and magnifying glass, and put the gizmos through their paces. Then we build forts from their empty boxes and have snowball fights with the packing peanuts. Finally, we pass along our informed opinions to the most elite people in the world – yes, I'm talking about you, precious reader – in our weekly newsletter. *Wired Gadget Lab* gives you the up-to-date lowdown on all the latest tech. Take a gander at some of the most memorable merch we've had the opportunity to love – or hate – over the past year. And to get new gear gossip delivered to your inbox every Tuesday, mosey on over to www.wired.com/gadgetlab.

**Aibo ERS-7 Robotic Canine****[RETAIL: \$1,799]**

Keeping my kids' attention is a sort of bot Turing test – if Aibo could pass, then it would be a smart dog indeed. The good news is that the baby loved Aibo. The bad news is that the older kids spotted the dogbot's IQ flaws pretty quickly: Its vision and voice recognition are still primitive. Although geek dads know it's technically impressive that Aibo can nudge a pink ball across a room, it's not that much fun to watch more than once. – **Chris Anderson**
[RATING: 6/10] [www.us.aibo.com]

**Archos AV420 Pocket Video Recorder****[RETAIL: \$550]**

The AV420's dock and video inputs make recording a snap. I ripped Justin Timberlake from MTV to the 20-gig hard drive so I could review his dance moves on the bus. The included PC-side software can convert Kazaa'd digital video to the AV420's preferred DivX format, but DVD recordings – and other copy-protected video sources – can't be exported. Still, a little DRM-tethering is better than being stuck watching video in the living room. – **Brian Lam**
[RATING: 8/10] [www.archos.com]

**Arkon LavNav Toilet Night-Light****[RETAIL: \$30]**

Late-night trips to the bathroom used to leave me in the dumps. I would stumble groggily to the can with my near-bursting bladder, only to be blinded when I flicked on the 100-watt bulb. Enter the LavNav: The lid-mounted night-light has a built-in motion detector that senses my approach, gently lighting my way. And it's a royal flush for couples, glowing a verdant green if the seat is down and a night-vision red if it's up. Ladies, say tootle-loo to those embarrassing midnight dips. – **Stuart Luman**
[RATING: 9/10] [www.arkon.com]

**Fossil Abacus Wrist Net Watch****[RETAIL: \$129, plus \$10 monthly subscription]**

OK, it failed the wife test – she laughed at the plasticky design, stiff band, and face so thick I can't button my shirt cuff. It also needs to be recharged every three days or it atrophies into a plain old digital watch. I liked glancing down to see stock quotes or headlines and having my Outlook calendar autosynced to my timepiece, but I think I'll wait for the next version (with motion recharging, please) before daring to bare my wrist again. – **C.A.**

[RATING: 4/10] [www.abacuswatches.com]



FunSlides Carpet Skates

[RETAIL: \$15]

These brightly colored sheets of plastic made crossing Cubicleland a lot more fun. I lashed them to the bottoms of my shoes and skidded around the office like a sock-footed third grader on freshly waxed linoleum. The ridged tips grip carpet while you run, helping you build up speed for long slides. Some coworkers laughed. Others cheered. Most just silently waited for me to face-plant into the copy machine.

– Robert Capps

[RATING: 7/10] [www.funslides.com]



LED Binary Clock

[RETAIL: \$23 (silver), \$20 (red)]

Am I geeky enough? Sure, I talk a good game ... but I don't know how to work a slide rule, and my C++ code never compiles. To shore up my cred, I learned to tell time in binary. The 20 LEDs on this clock replicate the 0/1, on/off system of telling time (e.g., 0001 equals 1, 0010 equals 2, 0011 equals 3, et cetera). Now if anyone dares challenge my alpha geekhood, I can just say, Can't school you now, N00B, it's 0101 minutes past 0111 and I gots to go catch *Star Trek!* – CHR15 B4K3R

[RATING: 0111/1010] [www.thinkgeek.com]



Shower Shock Caffeinated Soap

[RETAIL: \$7]

I never have the energy to brew coffee in the morning. Lucky for me, this bar of soap doles out 200 milligrams of soul-nourishing caffeine per wash – equal to about two cups of joe. The 4-ounce bar made my skin tingle, and after a few minutes in the tub I felt so energized I wanted to re-spackle the whole bathroom. Best of all, no coffee breath. – C.B.

[RATING: 10/10] [www.thinkgeek.com]



Solid Alliance i-Duck USB Drive

[RETAIL: \$169]

Little i-Duck, you're the one / Who makes data storage fun! / Little duck with 256 megs on you / Woo woo be doo / Little i-Duck's kind of slow / You're not USB 2.0 / Little duck, glad there's an upgrade for you / Woo woo be doo / Little i-Duck, you're so fine / I'm lucky that you're mine / Little i-Duck, I'm awfully fond of ... / Little i-Duck, I'd like a whole pond of ... / Little i-Duck, I'm awfully fond of you! – Dom Nguyen

[RATING: 6/10] [www.dynamism.com]



Sonic Alert Sonic Boom Alarm Clock with Super Shaker Bed Vibrator

[RETAIL: \$70]

This alarm clock is meant to wake the hearing impaired with its triple-pronged attack on z's, but it also works on the lazy. At 8 am, the 113-dB siren wailed like a banshee, the 12-volt under-the-mattress shaker shook like an earthquake, and the built-in 110-volt outlet made my lamp flicker like lightning. I suppose the next version of this sleep slayer will pull off your blankets and dump ice water on your crotch. – B.L.

[RATING: 9/10] [www.sonicalert.com]



P3 International Doctor Frog Plant Monitor

[RETAIL: \$6]

My daffodils were droopy and my petunias were parched, but Doctor Frog helped me nurse them back to health. When the doc's moisture sensors get dry, he croaks, nagging me to water the plants. But Prince Charming's got a hole in his torso, so I have to remember to uproot him before dousing the plants or risk a short circuit. Still, there's no better reminder for keeping your flora fed. – B.L.

[RATING: 9/10] [www.p3international.com]



COMMUNICATION

Mobile Phones

With even low-end models piling on the features, the most tricked-out handsets do everything but the talking. **by Cathy Lu**

- 25 **Multifunction Phones**
- 28 **Megapixel Phonecams**
- 30 **Phone-PDA Hybrids**

PLUS:
33 **Internet Phone Services**

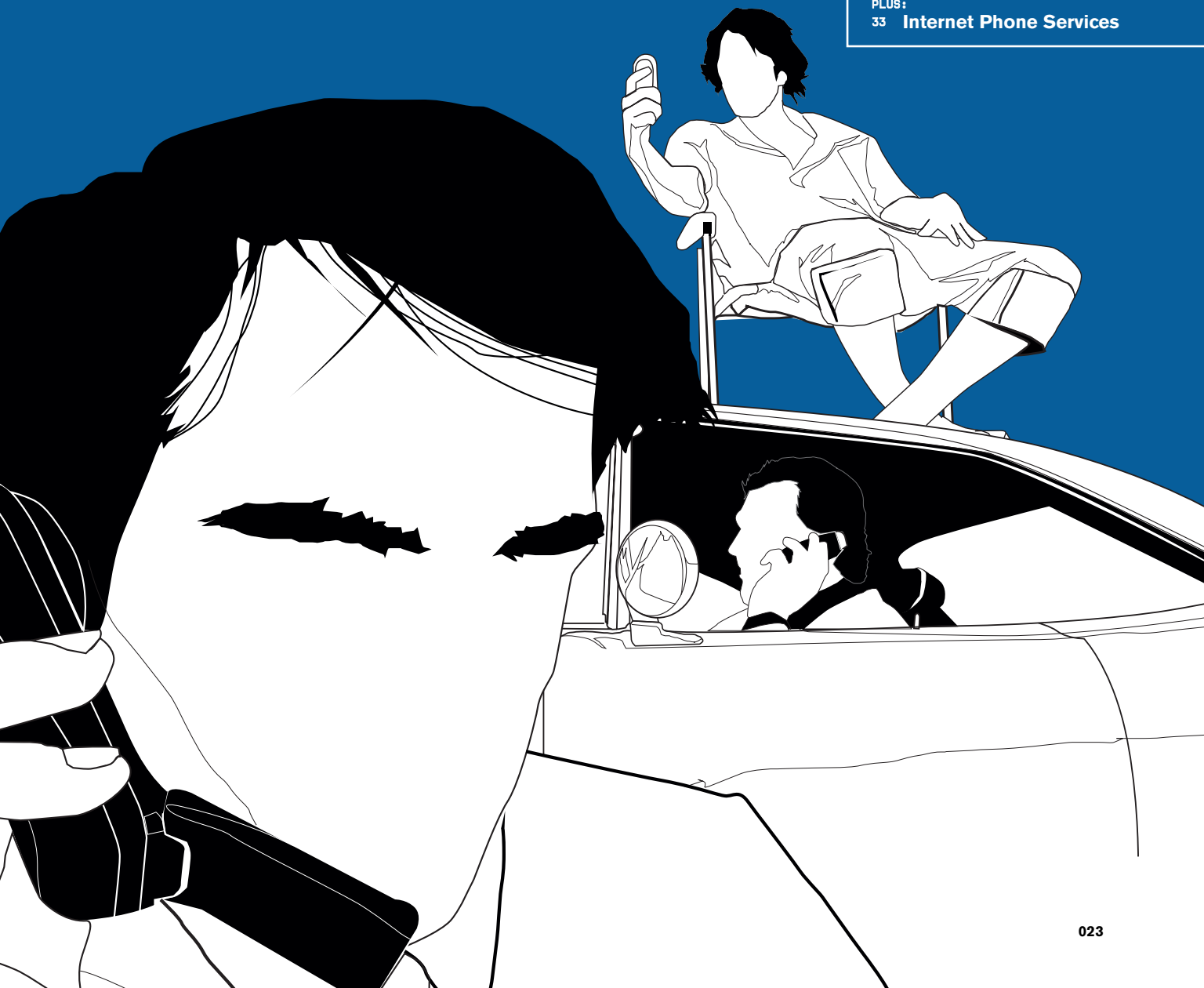

Mobile Phone Essentials

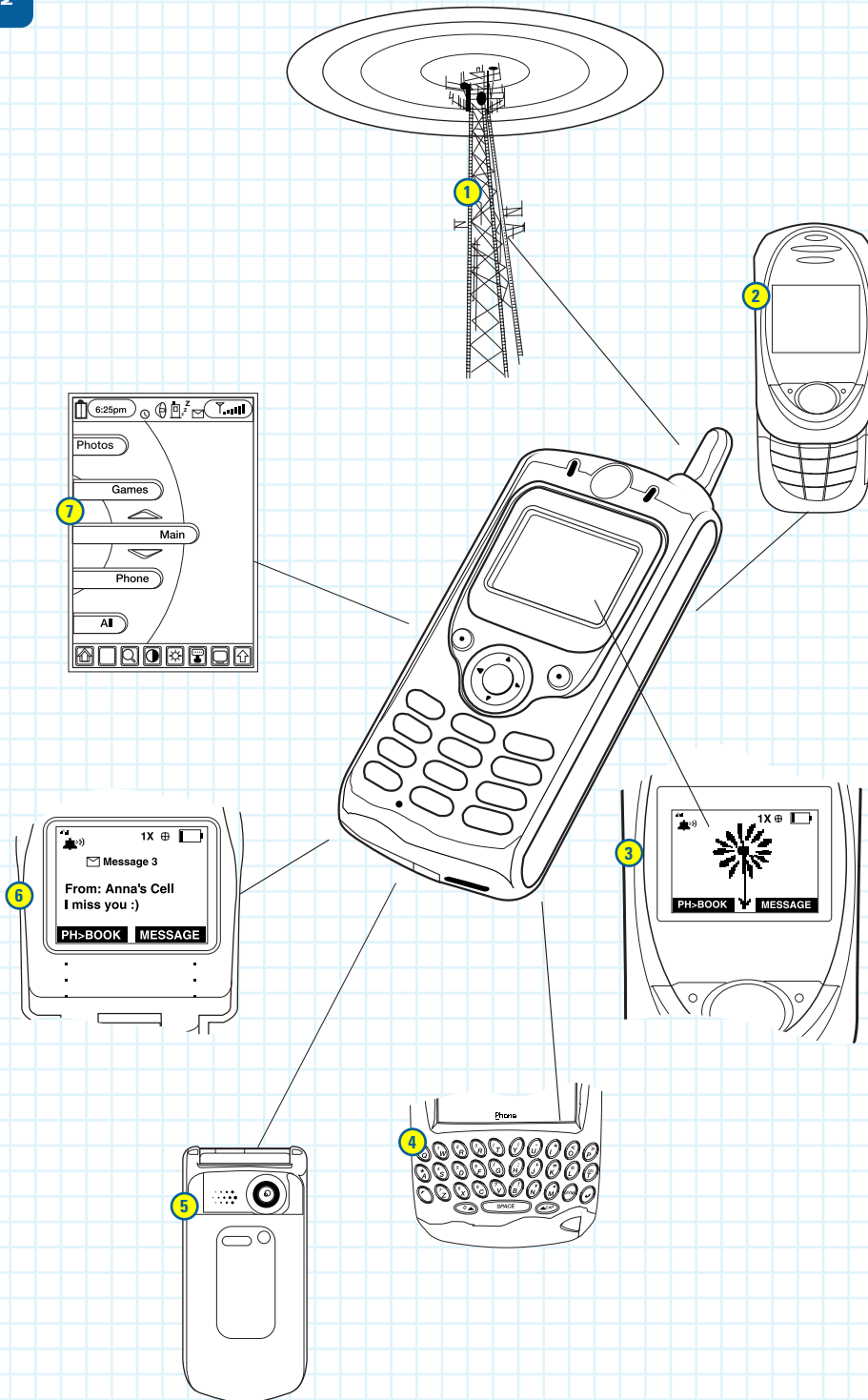

1 NETWORK STANDARD
Cell phones in the US are either CDMA or GSM, depending on the carrier. Sprint and Verizon use CDMA, while AT&T, Cingular, and T-Mobile use GSM. (See glossary, page 32, for a jargon breakdown.)

2 FORM FACTOR
Options include swivelers, clamshells, and sliders. Try them out and get the kind that feels best in your hand and your pocket.

3 SCREEN
If you plan to use your phone for Web browsing, text messaging, or photo and video viewing, treat your eyes to a big, bright screen with high resolution and lots of colors.

4 KEYPAD OR KEYBOARD
Text-message and email junkies will want a QWERTY keyboard. Nonaddicts should stick to a standard keypad.

5 CAMERA
VGA resolution (0.3 megapixels) is the norm on US phones, though 1-megapixel models are now available. In Japan, phonecams run as high as 3 megapixels.

6 MESSAGING
Most mobiles use SMS for text and MMS for multimedia messaging. Some are also compatible with PC and Mac apps like AOL Instant Messenger and Yahoo! Messenger.

7 OPERATING SYSTEM
Some devices (the Sidekick II, for instance) use a proprietary operating system. Others run on a third-party OS such as Microsoft Windows Mobile, Palm, or Symbian. The latter two tend to give you more choices for applications that extend your phone's capabilities.

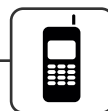

Multifunction Phones

These slim handsets are anything but stripped-down: They play music files, keep you organized, and even surf the Web.



◀◀ LG VX7000

Putting a new twist on the camera phone, the VX7000 clamshell has a rotating lens embedded in its hinge. Flip the lens forward for paparazzi pics and back for self-portraits (though the 640 x 480-pixel photos aren't fabulous). The keypad layout and menu system inside go easy on the fingers, while the blue exterior looks snazzy.

\$250, www.lge.com



↑ WIRED

Beautiful, clear screen. On-the-fly zoom and brightness control. Built-in flash works pretty well. 176 x 144-pixel, 15-fps video is smooth.

↓ TIRED

Lens flips require pushing a button to reorient the image onscreen. 15-second limit on video.



◀◀ MOTOROLA A630

Psst, wanna buy a mini keyboard? The clever overleaf design of the A630 reveals a full QWERTY thumbpad within. Turn the phone sideways to tap through the Internet, check email, and compose text messages on the 220 x 176-pixel display. Fold it closed and you're ready to snap pics or chat with friends.

\$200-300, www.motorola.com



↑ WIRED

Packs a full keyboard in a candy bar-sized phone. Built-in Bluetooth for use with hands-free headsets. VGA camera lets you cycle through lighting modes.

↓ TIRED

Keyboard makes phone a bit thick and heavy. Interface cumbersome for entering contacts.



◀◀ NOKIA 6230

Don't let the mild-mannered appearance fool you: The 6230 is a multimedia monster. It can take 640 x 480-pixel pictures, capture four-minute video clips, and play MP3 and AAC music files or FM radio broadcasts – doing the work of a sackful of gadgets. Thanks to an MMC slot under the battery, it can also store your digital wares.

\$300, www.nokia.com



↑ WIRED

Video clips are superlong compared with other phones. Music player has potent equalizer, and radio has 20 station presets. Bluetooth-equipped.

↓ TIRED

Easy to misselect items using tiny navigation pad. Display is small for Web or video. Pics are fuzzy.

QUICK TIP

If a phone's features include Bluetooth or email, check that the carrier has fully implemented it.

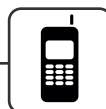

◀ SAMSUNG VM-A680

The VM-A680 just feels right. Despite being ultrasmall and ultralight (3.3 x 1.8 x 0.9 inches and 3.4 ounces), it has a comfortable, smartly arranged keypad. Samsung markets it as a videophone – the handset takes VGA pics and lo-res 15-second video clips – but we found the slim design a much more appealing trait.

\$150, www.samsung.com



↑ WIRED

Great compact form. Intuitive interface. Good button layout.

↓ TIRED

Video is at a squint-inducing 128 x 96 pixels (the lowest res we've seen), and dimly lit video is very choppy. Teeny screen.



◀ SIEMENS SX1

With light-up-blue buttons straddling a spacious screen, the SX1 looks intriguing. However, the funky design makes dialing awkward. On the plus side, it includes a video and still camera, FM radio, and PDA-like organizing and syncing functions. Siemens gets points for creativity, but what good is a phone that's too tough to dial?

\$600, www.siemens-mobile.com



↑ WIRED

Roomy 2.2-inch display. FM radio; plays MP3 and RealAudio files. Captures decent 176 x 144-pixel video clips up to 30 seconds long. Built-in Bluetooth and MMC slot.

↓ TIRED

At 4.3 x 2.2 x 0.7 inches, it's on the big side. Split keyboard makes one-handed input impossible. Pics overexposed. Absurdly expensive.



EDITORS' PICK ✓

◀ SONY ERICSSON K700

The K700 is a compact, attractive performer that does a little of everything. Photo quality is good for VGA (0.3-megapixel) resolution, and the 220 x 176-pixel display is gorgeous. We found the keypad a bit cramped, but with Bluetooth for PC syncing, and a radio and media player for video and MP3s, there's a lot to like here.

\$399, www.sonyericsson.com



↑ WIRED

Exceptionally clear screen. Built-in radio. Well-organized contacts interface. Tiny mirror on the back helps the vain take self-portraits – or fix their hair.

↓ TIRED

Buttons are too close together when dialing. Connector cover is a pain to remove when charging. Low-light images look grainy.

SNEAK PEEK



◀ MOTOROLA RAZR V3

The thinnest models get all the attention in the fashion magazines – and in the gadget world. Measuring a slight 0.5 inch thick, just over 2 inches wide, and less than 4 inches long, this clamshell slips stealthily into the back pocket of a pair of hip-huggers. The stunning keypad, chemically etched into a single sheet of nickel-plated copper alloy, is matched by an equally gorgeous hi-res, 2.2-inch display. Other turn-ons: VGA camera, built-in Bluetooth.

Price TBA, www.motorola.com

DUE ON SHELVES:

By 2005.

WORTH THE WAIT?

If you like jealous stares: Having a Razr V3 will be like going to a party with Uma Thurman on your arm – the envy will be palpable.

Megapixel Phonecams

The first talk-and-shoots were fashion forward, but their snaps were cheesier than a Von Dutch hat. This season's are good enough for 4 x 6s – and most do video.



◀ AUDIOVOX CDM-8920

Although it's one of the smallest, this clamshell has a comfortable keypad for error-free dialing. The 1.3-megapixel images benefit from advanced controls, including white balance, brightness, color effects (like sepia), and a Macro mode for warts-and-all party shots. The 1,280 x 960 pics are sharp, but colors are off.

\$300, www.audiovox.com



↑ WIRED

Small and reasonably light. Bright, clear display. Self-portrait mode previews shots in a secondary display that faces you.

↓ TIRED

No video capture. Inaccurate colors. Low-light pics grainy, even with flash. Nominal zoom.



◀ KYOCERA KOI

Kyocera dares to be different with its pinwheel menus and a funky swiveling display. Though we sometimes found ourselves twisting the screen the wrong way to get at the keypad, there are camera settings galore, including brightness, white balance, and a self-timer. Snapping pictures with the phone closed is also a major plus.

\$200-300, www.kyocera-wireless.com



↑ WIRED

Gee-whiz form factor. Giant display is always visible. Nicely laid-out keypad. The 1,280 x 960 images feature some of the truest colors you'll find.

↓ TIRED

Photo-transfer software for Windows only. Auto flash didn't always fire when needed.

Mobile Phones How We Tested

ALL PHONES



PORTABILITY

We carried around each phone for a few hours to see how pocketable it was.



MENU SYSTEM

To get our heads around the interface, we made calls, entered contacts, and used any messaging systems available.

MEGAPIXEL PHONECAMS



LIGHTING

Pictures were taken under three different sets of conditions: outside in full sunlight, indoors in natural daylight, and indoors in low light. We cranked the resolutions to the highest levels and left all other settings on default.



IMAGE QUALITY

We compared the cameras' image quality by viewing photos on a 17-inch LCD monitor and making 4 x 6 printouts.

PHONE-PDA HYBRIDS



WEB BROWSING

Several Web sites were viewed using the included browser.



EMAIL

We set up email accounts and corresponded with colleagues.



ORGANIZER

Each hybrid's contact-management apps, calendar functions, and task capabilities – memos, to-do lists – were put through the paces.



SYNC

We synced each device with an Outlook 2003 database, and some with additional information managers such as Lotus Notes.

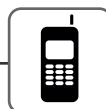

◀ MOTOROLA V710

This megapixel flip phone from Motorola neither dazzles nor disappoints. Its 2.2-inch display is nice for viewing the 1,280 x 960-pixel pictures, which have fine color but aren't terribly sharp. But oddities limit this phone – it uses a strange choice of expansion slots (TransFlash, anyone?), and currently Verizon (the V710's carrier) restricts the Bluetooth implementation.

\$200-300, www.motorola.com



↑ WIRED

Nice picture color – when there was enough light. Outstanding camera interface includes a memory-use indicator. 176 x 144 video pretty good for a phone.

↓ TIRED

Awkward contact manager. Pics somewhat blurry and pixelated. Camcorder difficult to access.



◀ NEC 535M

At just over an inch thick, NEC's clamshell is lean and luxurious. It has a knockout 2.4-inch screen, and the 1.3-megapixel camera produced the best pictures of any phone we tested – crisp details and true colors up to 1,280 x 960-pixel resolution. But the interface and navigation are somewhat clunky.

\$349, www.necwireless.com



↑ WIRED

Sumptuous LCD. Stand-out photo quality. Full-sounding speaker. No digging in menus to turn on flash or adjust zoom and brightness. Decent video.

↓ TIRED

Handset a little long. Can't view photos from within camera mode. No Bluetooth.



◀ NOKIA 7610

The 7610 is sleek, sexy, and big – like a stretch limo. The 1-megapixel cam's 1,152 x 864 pictures are respectable, just don't expect shots of you and your friends clubbing to turn out (no flash). Where the 7610 really shines is in motion: It captures up to 10 minutes of 174 x 144-pixel video, which you can download to your PC using Bluetooth or USB 1.1.

\$400 (estimated), www.nokia.com



↑ WIRED

Big, clear display. Movie Director software lets you stylize video and reduce file size for sending via MMS. Cool Lifeblog app organizes videos and pics by day.

↓ TIRED

Swoosh keypad layout takes some adjusting to. Some buttons difficult to press. Blah interface. No built-in flash.

SNEAK PEEK



◀ LG VX8000

LG's first megapixel model for the US is a clamshell with all the usual phonecam fare – white balance, brightness, color effects. More interesting is its support for EV-DO (a high-speed CDMA-based data network), which could enable streaming video and video-on-demand, if carriers offer those services. (Verizon and Sprint plan to roll out EV-DO nationwide.)

Price TBA, www.lge.com

DUE ON SHELVES:

By early 2005.

WORTH THE WAIT?

More than a 1-megapixel phone, the VX8000 could be a mean videostreaming machine – if carriers' plans materialize.

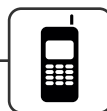

Phone-PDA Hybrids

Like PB&J, cell phones and PDAs just go together. These smartphones keep on top of your contacts, datebook, messaging, and email. Just don't smudge the screen.

CHEAP THRILL



◀ DANGER SIDEKICK II

If you **type** more than you talk, the Sidekick II is the perfect hip companion. It comes with a Web email account and can monitor up to three additional POP3 or IMAP addresses. Messaging is a breeze thanks to the QWERTY keyboard beneath the screen. But as phones go it's unnervingly big, and you speak into the back – weird.

\$299, www.danger.com



↑ WIRED

Full-size keyboard. Intuitive wireless syncing. Informative interface tells you how many messages you have.

↓ TIRED

No basic keypad: Dialing requires either swiveling out the screen or fumbling through menus. Chunky.



◀ HP iPAQ h6315

If you're **already** sold on Pocket PC devices, why not get one with a built-in GSM phone? The iPaq h6315 is packed to the gills, including Wi-Fi, Bluetooth, and a VGA camera. Of course, at 6.7 ounces the h6315 is more PDA than phone, and the clunky snap-on keyboard doesn't help.

\$500, www.hp.com



↑ WIRED

Beautiful 3.5-inch screen makes Web browsing a joy. Supports AOL, MSN, Yahoo!, and ICQ instant messaging. Touchscreen. Windows Media Player for music and video.

↓ TIRED

Big and heavy. Keyboard can be unresponsive. Limited 64 Mbytes of SDRAM.



EDITORS' PICK ✓

◀ PALMONE TREO 600

It's **more than** a year old, but the Treo 600 is still the best phone-PDA combo available. It runs on the Palm OS, and the pleasantly domed keys, QWERTY keyboard, and touchscreen ease data entry. The Treo 650, due by the end of the year, closes the gripe gap by adding a hi-res 320 x 320-pixel screen and Bluetooth.

\$500, www.palmone.com



↑ WIRED

Compact design feels more phonelike than other devices. Tight integration of Address Book and Phone applications. Handles up to five email accounts.

↓ TIRED

Closely spaced keys led to lots of "Johms" in our contact list. No built-in instant messaging.

SNEAK PEEK



◀ RIM BLACKBERRY 7100t

Unfortunately, this new slimmed-down BlackBerry came out as we were going to press, so we didn't have time to fully review it. RIM's first consumer BlackBerry retains the boring business model's navigation and interface, but it's smaller and has a higher-quality color screen. No QWERTY keyboard, but RIM provides an innovative abridged take on mobile typing – a pad with two letters per key.

\$200, www.blackberry.com

DUE ON SHELVES:

By November 2004.

WORTH THE WAIT?

It puts the power of a BlackBerry into a hip design, so if you can adjust to the tighter keyboard, it'll make every day casual Friday.

Glossary: The 411 on MMS, GPRS, WAP, EDGE ...

TMI! WTF are you supposed to do when you go to the local wireless store and get an earful of GSM, 3G, and EV-DO? Before you LOL or say TTFN, check out our mobile ABCs.

3G Third-generation wireless standard that provides extra bandwidth for data, as well as voice.

CDMA Code division multiple access. Along with GSM, one of the two major wireless standards. Used by Sprint and Verizon.

CRAP Completely ridiculous alphabetical process. Why is it that on alphanumeric "shortcut" keyboards, it takes four taps to get an S? That's total CRAP.

EDGE Enhanced data for global

evolution. An extension of GSM that promises 384-Kbps data rates.

EV-DO Evolution, data only. Part of the CDMA 3G wireless standard, EV-DO offers speeds of up to 2.4 Mbps.

GSM Global system for mobile communications. A wireless standard that competes with CDMA. Supported by AT&T, Cingular, and T-Mobile.

GPRS General packet radio service. Enables faster data communications on GSM networks. A so-called 2.5G

standard that transfers data at 115 Kbps.

MMS Multimedia messaging service. Like text messaging, but with pictures and video.

SMS Short message service. The industry term for text messaging.

WAP Wireless application protocol. A standard for putting the Web on phones.

YCO You're cut off. When a connection drops, for no apparent reason, right in the middle of an important call. — C.L.

Mobile Phones Scorecard

	Rating	Model	Price	Wireless Standard	Carrier	Size (inches)	Weight (ounces)	QWERTY Keyboard	Additional Features
MULTIFUNCTION PHONES	4	✓ Sony Ericsson K700	\$399	GSM	Any GSM	3.9 x 1.8 x 0.8	3.2	No	Camera, FM radio
	3.5	Motorola A630	\$200-300	GSM	Cingular, T-Mobile	3.7 x 1.9 x 0.9	3.9	Yes	Bluetooth, email
	3.5	Nokia 6230	\$300	GSM	Cingular	4.1 x 1.7 x 0.8	3.4	No	Camera, MP3 player
	3	LG VX7000	\$250	CDMA	Verizon	3.7 x 1.9 x 1	3.9	No	Clamshell, video
	3	Samsung VM-A680	\$150	CDMA	Sprint	3.3 x 1.8 x 0.9	3.4	No	Video
	2	Siemens SX1	\$600	GSM	Any GSM	4.3 x 2.2 x 0.7	4.1	No	Symbian OS
	*	Motorola RAZR V3	TBA	GSM	TBA	3.9 x 2.1 x 0.5	4.3	No	Superslim, Bluetooth
MEGAPIXEL PHONECAMS	4.5	✓ NEC 535M	\$349	GSM	Any GSM	4 x 1.9 x 1	4.3	No	2.4-inch screen
	4	Nokia 7610	\$400 (est.)	GSM	Cingular	4.3 x 2.1 x 0.7	4.1	No	Bluetooth, video
	3.5	Kyocera Koi	\$200-300	CDMA	TBA	3.9 x 2 x 1	4	No	Swivel design
	3	Motorola V710	\$200-300	CDMA	Verizon	3.7 x 2 x 0.9	4.5	No	Memory slot
	2	Audiovox CDM-8920	\$300	CDMA	Sprint	3.4 x 1.9 x 0.9	3.9	No	Preview display
	*	LG VX8000	TBA	CDMA	TBA	3.8 x 2 x 0.9	3.9	No	EV-DO support
PHONE-PDA HYBRIDS	4.5	✓ PalmOne Treo 600	\$500	CDMA, GSM	Major CDMA and GSM	4.4 x 2.4 x 0.9	6.7	Yes	Palm OS
	4	Danger Sidekick II	\$299	GSM	T-Mobile	5.1 x 2.6 x 0.9	6.2	Yes	Proprietary OS
	3	HP iPaq h6315	\$500	GSM	T-Mobile	4.7 x 3 x 0.7	6.7	Yes	Pocket PC OS
	*	RIM BlackBerry 7100t	\$200	GSM	T-Mobile	4.7 x 2.3 x 0.8	4.3	Abridged	Bluetooth, email

* Product not available in time for testing.



Internet Phone Services

Voice over IP lets you dump Ma Bell but keep your old phone. Choose a provider, plug in an adapter, and you've got a digital line. – Gordon Bass

VONAGE SHOWN

With VoIP services, you can't always hold onto your phone number or even, in some cases, your area code. But this industry pioneer lets you choose among codes from 40 states. Vonage also offers a first-class online account-management tool and voicemail access from any PC. A separate fax line is available for 10 bucks a month. **\$25 per month for unlimited US and Canadian calls, www.vonage.com**



AT&T CALLVANTAGE

CallVantage delivers all the goods – from online message retrieval to a “do not disturb” feature (calls are automatically routed to voicemail) – and it's easy to use. Area codes from 39 states and DC are available.

\$30 per month for unlimited US and Canadian calls, www.callvantage.com



VERIZON VOICEWING

Verizon's service may be pricey, but setup is a breeze. Online account management is straightforward and feature-rich: You can retrieve voicemail, set up call forwarding, and maintain an address book. But you can't send faxes.

\$40 per month for unlimited US calls, www.verizon.com/voicewing



8X8 PACKET8

The price is right, installation is easy, and voice quality is superb. Area codes from 46 states and DC can be had, and the basic monthly fee includes faxing. Unfortunately, the online account-management features are few.

\$20 per month for unlimited US and Canadian calls, www.packet8.net





CAMERAS

Digital Cameras

More megapixels, smarter processors, and faster autofocus put stunning pics within the reach of any aspiring artiste. **by Marty Katz**



- 37 **Pocket-Sized Cameras**
- 41 **Full-Featured Compact Cameras**
- 42 **Digital SLR Cameras**

PLUS:
44 **Photo Printers**

Digital Camera Essentials

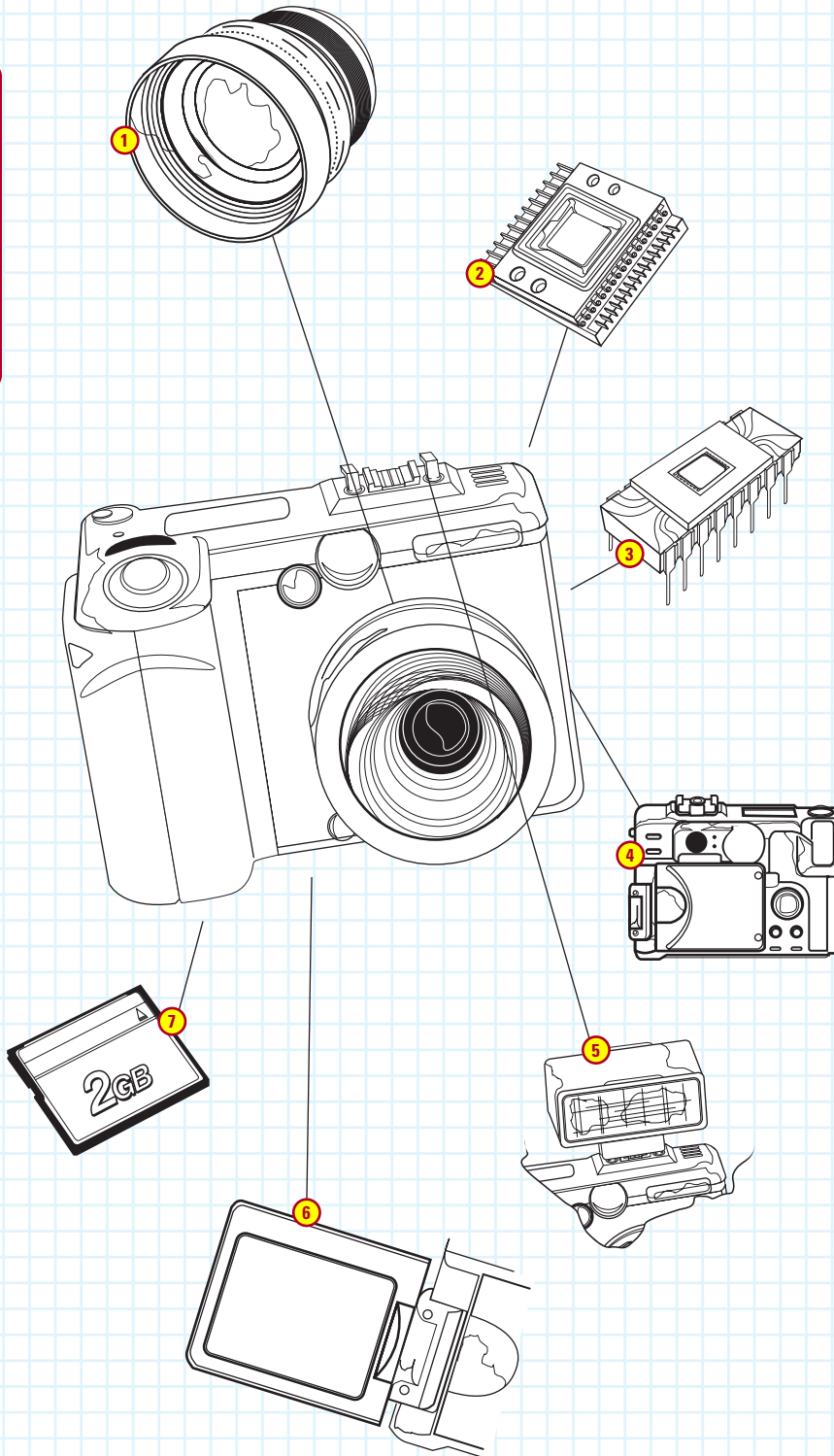

1 LENS

Most compacts offer a zoom range of around 35 to 120 mm (35-mm film equivalent). Wider angle – 28 mm or lower – is useful for tight spaces. SLRs have interchangeable lenses that let you shoot in just about any situation.

2 IMAGE SENSOR

Using either CCD or CMOS technology, the sensor turns captured light into digital pixels. The more megapixels recorded, the bigger the photo can be printed. But take note: More megapixels does not always equal better overall image quality.

3 PROCESSOR

The processor matters as much as megapixels. It corrects color balance, determines how fast the lens focuses, and cleans up noise, or pixel aberrations. In general, the newer the camera model, the better the chip.

4 CONTROLS

Function buttons should be arranged logically and onscreen menus easy to navigate. You should be able to make quick adjustments on the fly.

5 FLASH

If the flash is too close to the lens, it can cause red-eye. Digicams with a hot shoe let you attach a more versatile and powerful external flash.

6 SCREEN

Tiny cameras don't necessarily have tiny screens. Big LCDs help with composition and reviewing pics. Some swivel and twist, allowing you to, say, hold the camera above your head.

7 MEMORY CARD

Most compacts use Secure Digital cards, while SLRs typically use CompactFlash. Formats like xD or Memory Stick are less versatile and more expensive.



Pocket-Sized Cameras

Small enough to take anywhere, these slim cams pack enough features to satisfy anyone, from the point-and-shooter to the professional on holiday.

3- AND 4-MEGAPIXEL CAMERAS ▼

CHEAP THRILL



◀ CANON POWERSHOT A85

Intended as an entry-level, 4-megapixel quick snap, the A85 surprised us. It provides fast shutter response, low noise even at ISO 400 sensitivity, and smart focusing. Naturally lit pictures come out at higher quality than those from other pocket cams. Its main drawback: pudginess.

\$299, www.canonusa.com



↑ WIRED

Enlarges playback images up to 10X. Flash and ambient light mix nicely. Excellent pictures in low light. Takes AAs.

↓ TIRED

Slow autofocus with moving subjects in low light. Heavy.



◀ CASIO EXILIM EX-S100

The 3.2-megapixel S100 is a mere 0.7 inch thick and nearly credit card-sized at 3.5 x 2.2 inches. But thanks to a new, highly refractive ceramic lens material, it has room for a 2.8X optical zoom. Like the other Casios we tried, it looks sleek, shoots quickly, and possesses an intuitive (and sophisticated) user interface.

\$400, www.casio.com



↑ WIRED

Tiny, with huge feature set and great performance. Not-too-noisy ISO 400 catches action and dimly lit scenes.

↓ TIRED

These days, 3.2 megapixels leaves us hungry and seems skimpy for the price. Not superlight at 4 ounces. No optical viewfinder.



◀ OLYMPUS STYLUS 410 DIGITAL

This cam continues Olympus' film-era trend of making small, weather-resistant point-and-shoots. With a sliding lens door for extra armor, the tiny 4-megapixel digicam is easy to use and takes very good pictures in a variety of lighting situations. Too bad it uses hard-to-find xD memory cards.

\$349, www.olympusamerica.com



↑ WIRED

At 5.6 ounces and 3.9 x 2.2 x 1.3 inches, it's small and cute. Well-designed cover grip. Flash mixes nicely with ambient light. Water-resistant (but not submersible).

↓ TIRED

Uses pricey xD cards. Focus delay with action shots in dim light.

Buying a Digital Camera

Some research and a bit of legwork will help you find the perfect digicam.

Skip the big-box stores. Sure, you'll find discounts, but you'll also endure hard sells by ill-trained workers pushing products based on price. Instead, find a local photo store that offers price-matching and makes its money on repeat business rather than sheer sales volume. You'll get informed advice from smart salespeople who can rescue you if you accidentally crush your new shooter's LCD.

Handle and shoot as many cameras as possible. Bring

your own memory cards to tote the shots home or print them at in-store kiosks. Memory cards are best bought at mass merchandisers or online. Stick to name brands on these, keeping in mind that recent stock will be more glitch-free than last year's models.

Finally, don't try to save money by purchasing a used digicam. They're quickly outdated and can be damaged in ways that may not be obvious at first glance. — M.K.



◀ PENTAX OPTIO 43WR

The **43WR** is a waterproof little block that takes good-quality 4-megapixel pictures and is perfect for shooting on the lake or during those messy family picnics. You can rinse it after a dip in ketchup or mud and resume shooting. While submersible, this digicam is not meant for shooting underwater. Startup is quick – the watertight internal zoom does not have to extend.

\$349, www.pentaxusa.com



↑ WIRED

Comfy shape with nonslip surface. Uses two beach-buyable AAs. Logical button arrangement. Voice recording to go with the photos.

↓ TIRED

Moving subjects causes auto-focus delays in flash mode. Confusing menu with tiny text.

SNEAK PEEK



◀ SONY CYBER-SHOT DSC-L1

The **diminutive** (3.8 x 1.8 x 1.1 inches and 5 ounces) yet eye-catching DSC-L1 is more than a fashion statement. Packed into it is a 4.1-megapixel sensor and a tiny but sensitive f2.8-5.1, 3X zoom lens. In our tests of an early unit, we observed quick shutter response, short time between shots, and acceptable graininess at ISO 400. Unfortunately, like most Sony cams it uses only Memory Sticks.

\$300, www.sonymstyle.com

DUE ON SHELVES:

By November 2004.

WORTH THE WAIT?

If size and style matter to you as much as serious specs.

5- AND 6-MEGAPIXEL CAMERAS ▼



◀ CASIO EXILIM EX-P600

The **P600** is a smart, feature-packed 6-megapixel camera with near-pro image quality. Nicely machined with a clean button layout, it performs such difficult tasks as mixing flash with sunlight for portraits. Features like in-camera authoring of HTML picture pages and a jet cockpit-like control view option require some learning but are useful. A 7-megapixel version, the EX-P700, is due in 2005.

\$550, www.casio.com



↑ WIRED

Fast shutter response. Can produce uncompressed TIFFs for sharp blowups. Bracketing allows it to shoot multiple exposure variations.

↓ TIRED

Somewhat grainy images at ISO 400. Flash doesn't mix well with ambient light for shooting objects beyond 10 feet.



◀ CASIO EXILIM EX-Z55

This 5-megapixel microcam's 2.5-inch screen takes up so much of its back that there's precious little room for the tiny buttons. But a new processor yields fast response, low power usage, and solid stills. One nice (and novel) feature: the ability to switch from normal to Macro mode without pausing.

\$449, www.casio.com



↑ WIRED

Ultrasmall: 3.4 x 2.3 x 0.9 inches. Makes HTML pic pages. Blazing 0.01-second shutter response and 1.6-second startup. Efficient: 400 pics per charge.

↓ TIRED

Minuscule optical viewfinder. Teeny buttons difficult to use.



EDITORS' PICK ✓



◀ NIKON COOLPIX 5200

It looks like a toy and is light enough to wear on a lanyard all day, but the 5.1-megapixel 5200 is a serious performer. It captures bustling street scenes with color and clarity worthy of *National Geographic*. Features range from hand-holding scene modes to pro-level options, like white-balance bracketing.

\$500, www.nikonusa.com



↑ WIRED

Tiny 5.5-ounce aluminum package. Great at mixing flash with ambient light. If you minimize screen use, the battery lasts for days. 12 megs of internal memory.

↓ TIRED

Cumbersome procedure for reviewing and deleting photos.

CAMERAS
DIGITAL CAMERAS



◀ SONY CYBER-SHOT DSC-T3

Building on the success of its thin T1, Sony's 5.1-megapixel, 3X-zoom T3 is even skinnier. It has an eyelid-like door instead of a sliding lens cover. And while it lacks an optical viewfinder (like the T1), the T3 boasts a sharp, 2.5-inch screen. Alas, Sony's expensive Memory Sticks make it too pricey to truly love.

\$500, www.sonystyle.com



↑ WIRED

Sleekly flat. Black version is downtown cool. Big, pretty screen.

↓ TIRED

Poorly placed flash with limited range caused red-eye. Auto white balance not very effective.

7-MEGAPIXEL CAMERAS ▼



◀ CANON POWERSHOT S70

A 28- to 100-mm zoom allows this 7.1-megapixel model to cover a wide sweep of scenery or an intimate portrait. (But you do sacrifice long zoom.) It has a bevy of high-end features, including the ability to simultaneously capture RAW and JPEG versions of an image (you'll need Canon's software to separate the bundled files).

\$599, www.canonusa.com



↑ WIRED

Wide angle of coverage. Focus and exposure bracketing. Protective sliding lens door. User-definable autofocus spot.

↓ TIRED

Short zoom. Poorly located erase button. Heavy at 12 ounces.

Digital Cameras How We Tested



STANDARD SHOTS

We took portraits of people at ISO 100, with and without flash. Focus was left on Auto and then set to Spot. We blew the images up and inspected their sharpness, color, and contrast.



SENSITIVITY

Working at ISO 400, we shot fast-moving subjects in miserable light – with and without flash. The pictures revealed focus delay and pixel noise.



MACRO

We photographed flowers up close to check for macro performance and color deficiencies.



WHITE BALANCE

Under poor light conditions – fluorescent and tungsten indoor lamps, sodium or mercury-vapor street and arena lights – we challenged the auto white-balance feature to produce pictures with no unnatural color cast.



FILL FLASH

With the flash on, we snapped portraits in bright sun to see if the fill defeated sharp shadows.



INTERFACE

We ran through settings and modes to evaluate ease of use and navigability.



◀ SONY CYBER-SHOT DSC-P150

Sony's 7.2-megapixel shooter keeps the older P100's small, curved-end body but adds refinements like a new CCD and processor. And what an improvement they make. Push the On button and the lens pops out instantly. Images are detailed and rich – and you'll need a big, expensive Sony-specific Memory Stick to hold them.

\$500, www.sonystyle.com



↑ WIRED

Maximum pixels in minimum volume: 7.2 megapixels in 4.4 x 2.1 x 1.1 inches. Fast shutter response. 5X image review.

↓ TIRED

Bright orange focus-assist beam startles subjects. Compact body means small 1.8-inch screen. Memory Stick only.

SNEAK PEEK



◀ OLYMPUS C-7000 ZOOM

The C-7000 is a serious attempt to make a 7.1-megapixel camera both pocketable and user-friendly. Though Olympus sacrificed features like a dedicated macro control button, the digicam's excellent zoom range (38 to 190 mm) should make up for it. Big prints are possible with uncompressed TIFF and RAW image files. Unfortunately, like other Olympus models, the memory card slot accepts only xD cards.

\$600, www.olympusamerica.com

DUE ON SHELVES:

By November 2004.

WORTH THE WAIT?

If you like big prints – and are prepared to buy lots of expensive xD memory cards.

Digital Camera Accessories

These three amigos are must-haves for any cybershooter.

1 Konica-Minolta SD-CF1 adapter

Slip a Secure Digital card into this device and you can use it in a CompactFlash slot. At last, you can use the same cards for your digital SLR and your pocket cam. And since most memory slots on PDAs, smartphones, and laptops are SD, you'll get the added joy of viewing and emailing your pics on location.

\$59, www.konicaminolta.com

2 Pelican L1 flashlight

Dangle this featherweight (0.9 ounce, 2.5 inches long) LED flashlight from your neck whenever you're shooting. The 6,000-candlepower beam, with the bluish-white color of daylight, is perfect for adding a bit of side lighting to a portrait subject. And in the dark, it's handy for a glance at camera controls. Plus, the Pelican is an energy miser, shining for up to 130 hours on four LR44 coin-type batteries.

\$16, www.pelican.com

3 Micro Solutions RoadStor

When you're sans computer, here's a way to make room on your memory cards, back them up, or transfer photos to CDs. This compact CD-RW/DVD-ROM runs on AC or batteries. It has a slot for CompactFlash, and with an adapter it can also take SD, SM, MMC, MD, and MS cards. The disc-spanning feature will automatically distribute multigig loads over several CDs. And you can gradually fill a disc in multisession burns. Look for a DVD-writing version in the near future.

\$269, www.roadstor.com





Full-Featured Compact Cameras

These models cater to enthusiasts searching for powerful creativity tools. With a full spectrum of manual controls and the latest sensors, some even rival pricier SLRs.



◀ CANON POWERSHOT G6

Canon's 7.1-megapixel digicam offers dedicated photos plenty, with a generous 35- to 140-mm zoom range, nine-point auto focus, and a rear-mounted thumb control dial. Using Super Macro mode, a 1-inch subject fills the frame from 2 inches away. Too bad it's so beefy (13.4 ounces and 4.1 x 2.9 x 2.9 inches) and has a processor from 2003.

\$699, www.canonusa.com



↑ WIRED

Can save image as RAW and JPEG simultaneously. Flash hot shoe.

↓ TIRED

Automatic white balance doesn't correct poor lighting well. Frequent red-eye problems.



◀ PENTAX OPTIO 750Z

The 750Z is light for its class, weighing 8.9 ounces, and small at 3.9 x 2.4 x 1.7 inches. It can save photos as either substantial 3-Mbyte JPEGs or 20-Mbyte uncompressed TIFFs, and features a 37.5- to 187.5-mm zoom. Photo quality is respectable, and it gets bonus points for the cool retro styling.

\$649, www.pentaxusa.com



↑ WIRED

Powerful flash. Large optical viewfinder. Can bracket a series of shots with variations of settings like white balance, contrast, and saturation.

↓ TIRED

Hard-to-read menus. Poorly placed flash easily covered by finger.



◀ SONY CYBER-SHOT DSC-V3

The DSC-V3 boasts a powerful infrared beam that lets you take monochrome photos in total darkness (or can help frame shots for the flash to illuminate). It's the only Sony cam we tried that, in addition to Memory Sticks, takes CompactFlash cards (yay!). It offers fast shutter response and low noise levels all the way to ISO 800. The resulting top-quality pics can be saved as RAW, JPEG, or compression-free TIFF files.

\$700, www.sonystyle.com



↑ WIRED

True night vision. Hot shoe for external flash. Retro knurled control knob. Pop-up flash can be canceled manually.

↓ TIRED

Flash range only 10 feet. Takes Memory Stick and CF but can't copy from one to the other.

QUICK TIP

For supersharp blowups, save images as uncompressed TIFF files.

Digital SLR Cameras

When image quality and performance matter most, serious photographers reach for the interchangeable lenses and lightning response of an SLR.



◀ CANON EOS DIGITAL REBEL

The sub-\$1,000 camera that brought 6.3-megapixel DSLR performance to the masses is still going strong, making fine pictures with controls that are limited for simplicity. Still, the Rebel works with all the high-end Canon lenses and flashes for when you're ready to work for Reuters.

\$899 (body only), www.canonusa.com



↑ WIRED

Near-pro results made easy. Sensitivity up to ISO 1600 with acceptable noise. 10X zoom for reviewing images.

↓ TIRED

Slow startup. Sluggish focus on dimly lit subjects. Plastic body.



◀ CANON EOS 20D

Whether you're a die-hard hobbyist or fledgling pro, this cam's for you. Inside is Canon's 8.2-megapixel sensor and new Digic II processor, which produce nearly noiseless ISO 1600 images and only slight graininess at ISO 3200. It features well-designed controls and solid construction but weighs 1.7 pounds.

\$1,499 (body only), www.canonusa.com



↑ WIRED

Faster than fast: 0.2-second startup, 0.065-second shutter lag, 5-fps bursts of up to 23 JPEGs, max shutter speed of 1/8,000.

↓ TIRED

Auto white balance performance could be better. Loud mirror slap. JPEG and RAW only – no TIFFs.



◀ NIKON D70

The D70's hefty 1.3-pound black body has the air of a more expensive SLR. Its companion 18- to 70-mm zoom (27- to 105-mm equivalent in 35-mm terms) sells for \$300 and covers a variety of needs well. Thanks to quick response and easy image review, the D70 performs well in rapid-fire situations.

\$999 (body only), www.nikonusa.com



↑ WIRED

Captures spectacular color and detail. Relatively noise-free up to ISO 1000, and acceptable to 1600.

↓ TIRED

No TIFFs. Packaged companion lens expensive.

SNEAK PEEK



◀ CANON EOS-1Ds MARK II

This gasketed, sealed, battle-ready digital SLR has a 16.7-megapixel CMOS sensor the size of a 35-mm film frame to take wide-angle shots. The 4-fps firing rate is not fast compared with other cams, but the files are huge. A buffer allows shooting bursts of 12 full-resolution JPEGs, and the camera can store them on either CompactFlash or SD cards.

\$7,000 (estimated; body only), www.canonusa.com

DUE ON SHELVES:

By November 2004.

WORTH THE WAIT?

Absolutely – if you can afford it.



SNEAK PEEK



◀ **NIKON D2X**

This versatile shooter, aimed at sports and studio photogs, captures 12.4-megapixel files at 5 fps or 6.8-megapixel frames at 8 fps. Nikon claims the D2X offers near-instantaneous power-on readiness and a shutter speed of 1/8,000 second. An optional Wi-Fi module can transmit images to your laptop or over the Internet and allows live remote control of the shutter, aperture, color balance, and bracketing.

\$5,000 (estimated; body only), www.nikonusa.com

DUE ON SHELVES:

By 2005.

WORTH THE WAIT?

Yes, if you need to shoot fast action under harsh conditions.

CAMERAS
DIGITAL CAMERAS

Digital Cameras Scorecard

	Rating	Model	Price	Megapixels	Memory Format	Additional Features	
POCKET-SIZED	3- AND 4-MEGAPIXEL	4	Canon PowerShot A85	\$299	4	CompactFlash	Uses AA batteries, plugs directly into PictBridge printers for quick prints
		3.5	Casio Exilim EX-S100	\$399	3.2	Secure Digital	Large 2-inch screen, stainless-steel body
		3.5	Pentax Optio 43WR	\$349	4	Secure Digital	Uses AA batteries, submersible, records 640 x 480 video
		3	Olympus Stylus 410 Digital	\$349	4	xD	Water-resistant, 10 selectable shooting modes
		*	Sony Cyber-shot DSC-L1	\$300	4.1	Memory Stick Duo	Bright transfective screen, comes in four colors
	5- AND 6-MEGAPIXEL	4.5	✔ Nikon Coolpix 5200	\$500	5.1	Secure Digital	In-camera red-eye editing, records 640 x 480 video, exposure bracketing
		4	Casio Exilim EX-Z55	\$449	5	Secure Digital	Large 2.5-inch screen, calendar function sorts photos by date
		3.5	Casio Exilim EX-P600	\$550	6	Secure Digital	Large 2-inch screen, in-camera HTML gallery authoring, 25-shot consecutive picture mode
		3.5	Sony Cyber-shot DSC-T3	\$500	5.1	Memory Stick	Large 2.5-inch screen, long 38- to 114-mm zoom, records 640 x 480 video
	7-MEGAPIXEL	4	Canon PowerShot S70	\$599	7.1	CompactFlash	Wide 28- to 100-mm zoom, focus and exposure bracketing
		3.5	Sony Cyber-shot DSC-P150	\$500	7.2	Memory Stick	Accessory docking station for TV playback of slideshows
		*	Olympus C-7000 Zoom	\$600	7.1	xD	Large 2-inch screen, extralong 38- to 190-mm zoom
	FULL-FEATURED COMPACT	4.5	✔ Sony Cyber-shot DSC-V3	\$700	7.2	Memory Stick, CompactFlash	IR beam allows shots in complete darkness, flash hot shoe, shoots TIFFs
		4	Pentax Optio 750Z	\$649	7	Secure Digital	Tilt-and-swivel screen, shoots TIFFs
		3	Canon PowerShot G6	\$699	7.1	CompactFlash	Long 35- to 140-mm zoom, flash shoe, rotating screen
SLR	4.5	✔ Nikon D70	\$999 (body only)	6.1	CompactFlash	Takes high-end DX Nikkor lenses, up to 1/8,000-second shutter speed	
	4	Canon EOS 20D	\$1,499 (body only)	8.2	CompactFlash	Takes high-end Canon lenses, 23-shot buffer, 9-point AF sensor	
	3.5	Canon EOS Digital Rebel	\$899 (body only)	6.3	CompactFlash	Takes high-end Canon lenses, 7-point AF sensor, 12 shooting modes	
	*	Canon EOS-1Ds Mark II	\$7,000 (est.; body only)	16.7	CompactFlash, Secure Digital	Takes high-end Canon lenses, 35-mm-sized sensor, ISO sensitivity up to 3200	
	*	Nikon D2X	\$5,000 (est.; body only)	12.4	CompactFlash	Takes high-end DX Nikkor lenses, large 2.5-inch screen, two-way 802.11g Wi-Fi module available, shoots TIFFs	

* Product not available in time for testing.



Photo Printers

High-quality inkjets have rendered retail photo labs obsolete. Now, memory card slots and USB inputs mean you can ditch your computer, too. — Lisa Cekan

CAMERA
PHOTO PRINTERS

CANON i9900 SHOWN

If you want big photos and have plenty of space, the i9900 is a great choice. This behemoth clocked the fastest print speeds, spitting out 4 x 6 photos in just 46 seconds and 8 x 10s in 2.5 minutes. Plus, it's the only model we tested that can handle tabloid-sized paper. This printer is expensive, but the results are stunning, with bold colors and fine detail.

\$500, www.canonusa.com



EPSON R800

At first glance, the R800 looks like any other eight-ink photo printer. But it has an edge — it can print directly onto inkjet-compatible CDs and DVDs. It even includes software for designing your own labels. And creating disc art is quick. Too bad the R800 takes so long for photos: more than three minutes to print a 4 x 6 and over five minutes for an 8 x 10.

\$400, www.epson.com

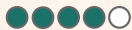

HP PHOTOSMART 8150

The Photosmart 8150 is well equipped and easy to use. Memory card slots? Check. An LCD that displays each photo? Yup. Separate trays for different-size paper? Sure. It even has a dial that allows you to choose border type or to lay out several photos on a single page. But the 8150 is slow, taking more than five minutes to print an 8 x 10.

\$199, www.hp.com

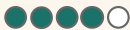

EPSON PICTUREMATE

Small and lightweight, with a built-in handle, the PictureMate pops out 4 x 6 photos on the go. There's even a \$50 car adapter, so you can catch up on printing while you're stuck in traffic. The memory card slots let you bypass a PC, but the small LCD doesn't display thumbnails — just menus. Colors were washed out.

\$200, www.epson.com





CAMERAS

Digital Video Cameras

These shooters help turn home movies into classics. Be the next Quentin Tarantino ... or Paris Hilton. **by Mathew Honan**

- 49 **MiniDV Cameras**
- 51 **Tapeless Video Cameras**



Digital Video Camera Essentials

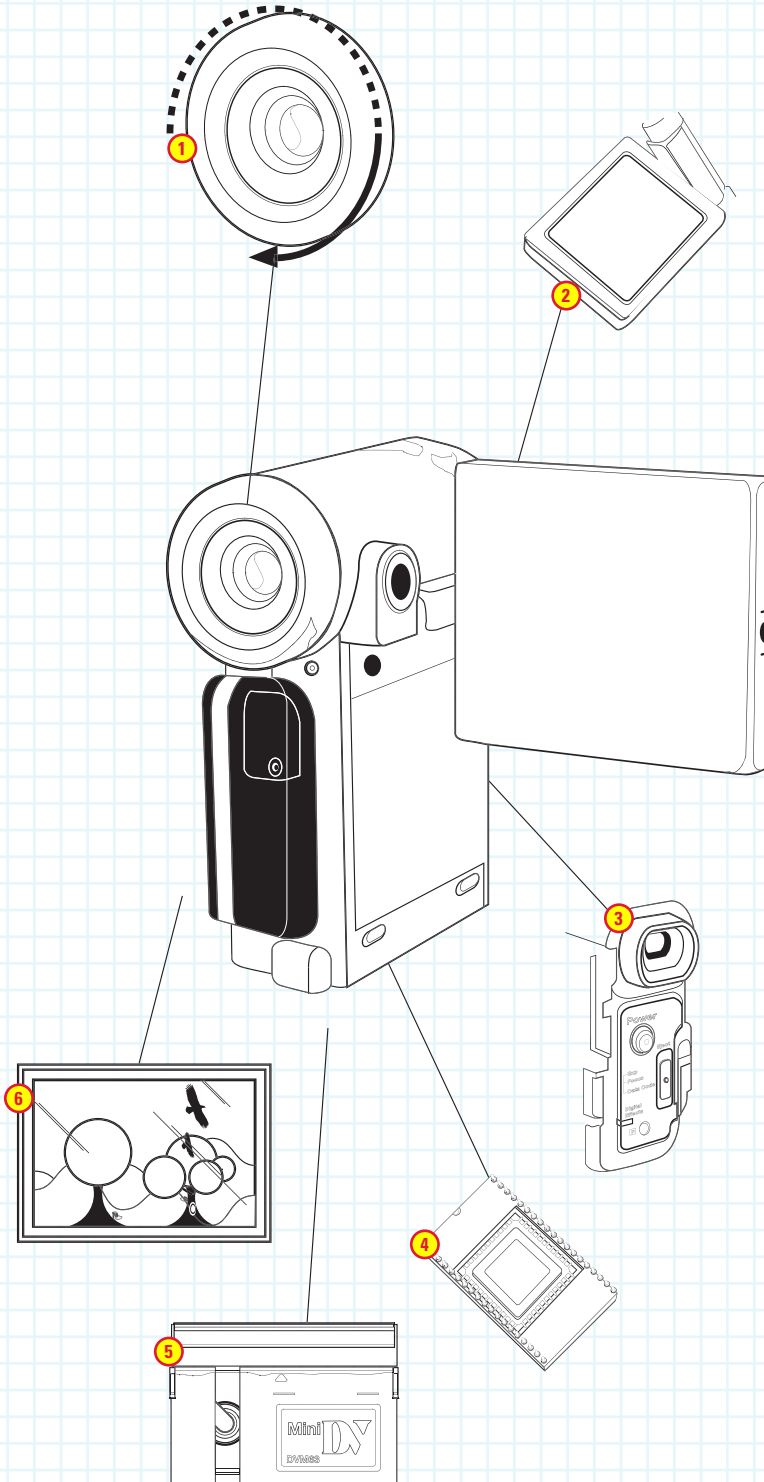

1 LENS

Select a camera that has a lens with a maximum aperture (f-stop) of f2 or lower. Optical zooms use the lens elements to “bring” an object closer – good. Digital zooms just enlarge pixels and can blur the image – bad. Some lenses feature variable speed zoom, which lets you choose how fast the optics move in and out.

2 LCD

Peering at a large, bright LCD is much easier than using a tiny viewfinder. The best screens can pivot to avoid the glare of daylight.

3 EXTERNAL CONTROLS

Get a DV cam with easy-to-use buttons that let you access manual controls, night-shooting options, and exposure settings with your thumbs instead of by scrolling through onscreen menus.

4 CCD

The charge-coupled device is a chip that converts light into digital video. Don’t get stuck on the number of pixels on a CCD. Physical size is paramount – the larger the CCD, the more light it can capture.

5 FORMAT

MiniDV cams write images to high-resolution digital tape. MPEG-4 cams shoot to flash memory or internal hard drives, sacrificing quality for size and convenience.

6 PHOTOS

The ability to take still pics is a nice extra, but image quality won’t match that of a stand-alone digital camera.



MiniDV Cameras

From toddler biopics to zoomed sports action, these compact camcorders add a professional touch to your amateur video.



◀ CANON OPTURA Xi

The Optura Xi is perfect for the weekend amateur looking for big-screen results. A star performer for outdoor action and for color- and white-balance handling, this cam also has a front-end stereo condenser microphone to filter out stray noise. Easy-to-use manual controls put superior image quality at your fingertips.

\$1,500, www.usa.canon.com



↑ WIRED

Fast f1.6 lens with 11X optical, variable speed zoom. Brilliant 3.5-inch LCD. Convenient pop-up flash. Big 0.29-inch CCD and 2.2-megapixel still camera.

↓ TIRED

Picture quality suffers in low light. At almost 8 inches long, the only pocket it fits into is a camera bag.



◀ JVC GR-DVP9US

Small enough to slip into the back pocket of your 501s, this camera boasts a chic, upright design. And the quarter-inch CCD is quite generous for a cam this tiny. The image quality isn't as good as we'd like, but it's pretty remarkable considering the JVC's size and price. Too bad there's nothing remarkable about its 1.3-megapixel still photos. They're hardly worth printing.

\$1,300, www.jvc.com



↑ WIRED

The most attractive miniDV cam out there. Ultracompact 3.2 x 1.8 x 4.6-inch body. NightAlive IR feature for shooting in darkness.

↓ TIRED

An annoying hum, audible in quiet settings and occasionally on tape. Dull reds. Overbright whites in automatic white-balance mode.



◀ PANASONIC GS15

This DV cam is relatively inexpensive and small enough to fit in a jacket pocket. Its 24X optical zoom shot past all challengers, though you'll need a tripod if you want to max it out. Be warned: Artists will curse the dull colors; video geeks will be disappointed with the lack of analog inputs; and aesthetes will be turned off by its bulk.

\$500, www.panasonic.com



↑ WIRED

24X optical zoom homes in on distant action. Three zoom speeds. Four LEDs indicate modes in the dark. Top-loading tape easy to access. Very quiet.

↓ TIRED

Big at 2.8 x 3.7 x 4.7 inches. Grainy image in low light.

QUICK TIP

If you're looking for high-resolution video and extensive manual controls, opt for a miniDV camera.



◀ SAMSUNG DUOCAM SC-D6040

The DuoCam's innovative over/under system uses separate lenses and CCDs for video and still images, making it the best DV cam we tested for taking photos. It was also the easiest camcorder to use, with intuitive menus and controls. Unfortunately, video is plagued by slow autofocus. The deal killers: It handles color poorly and routinely underexposes, resulting in dark footage.

\$900, www.samsungusa.com



↑ WIRED

Separate CCD for still images lets you shoot sharp 4.1-megapixel photos at up to 3X optical zoom.

↓ TIRED

Unwieldy 2.5 x 3.6 x 5.4-inch body. Tape noise audible on playback. Whites have ugly yellowish cast indoors; reds appear dull. Manual focus difficult.



◀ SONY DCR-HC65

This sporty model from Sony is the Swiss Army knife of shooters – small enough to go anywhere and loaded with tools. It was a close second in our action tests, thanks to its on-lens manual focus ring, variable speed zoom, and light-sucking f1.8-2.3 lens. The DCR-HC65 captures vibrant colors and details, maintains a stable image, and has a bright LCD that will please even demanding directors.

\$800, www.sonystyle.com



↑ WIRED

3.5-inch LCD seems positively gargantuan on a 2.4 x 3.5 x 6.5-inch camcorder. Colors are bright and vivid, especially reds. Fully automatic Easy mode for beginners.

↓ TIRED

Touchscreen menus awkward to use. Image grainy in low light.

Shooting Tips

Try some of these quick tricks for great DV flicks.

OVERSHOOT Grab more footage than you think you'll need. Digital video tape and flash memory are cheap – you can always edit.

FRAME SUBJECTS OFF CENTER For an artistic aesthetic, frame your subjects slightly off to one side of the composition, or shoot them in three-quarter profile.

TAKE SHORT CLIPS You'll have a much easier time editing if you have lots of short clips, rather than a few long ones. When there's a break in the action, take one yourself.

PAN SLOWLY Fast, sweeping camera work is one of the most common – and nauseating – errors of the amateur videographer.

WATCH THE SKY Too much blue overhead can detract from your subject and mess up color and contrast.

INVEST IN A FEW GOOD ACCESSORIES A tripod, separate microphone, and external light source can add sound and picture clarity.

WATCH THE ZOOMING Try to move closer to your subject rather than zooming in. And avoid digital zoom – it makes images pixelated and shaky.

DO YOUR WORK IN POST Built-in digital effects can create a dramatic shot out of a so-so one. But once you use an in-camera effect, you can't undo it. When possible, apply effects with your computer during the editing process so they can be undone.

GO MANUAL For better results than fully automatic modes, test-shoot on a large sheet of paper to calibrate white balance, set the shutter speed to suit the action, and monitor the audio levels yourself. – M.H.



Tapeless Video Cameras

Tiny MPEG-4 videocams shoot directly to either removable flash cards or internal memory, making for easy uploads to your computer.



◀ AIPTEK POCKET DV4500

The Pocket DV4500 feels as cheap as its price tag. From its plastic housing to its tendency to freeze up while shooting, this camcorder disappoints. At times, we could shut it off only by yanking out the battery. You'd do better with an Etch A Sketch.

\$150, www.aiptek.com



↑ WIRED

4-megapixel camera.

↓ TIRED

Poor-quality stills and lousy 352 x 288, 30-fps video. Images look washed out in good light, dark and grainy in low light. Very difficult to focus. No optical zoom.



◀ PANASONIC D-SNAP SV-AV100

Video from the chic SV-AV100 looks great on a TV thanks to its near-DVD-quality mode with 704 x 480 resolution (the included 512-Mbyte SD card holds just 10 minutes). This cam has the best zoom lens of our MPEG-4 herd. Colors and details were vivid, and video was sharp in hi-res mode. The trouble is, it's hard to hold something this small steady.

\$1,000, www.panasonic.com



↑ WIRED

10X optical zoom, 2.5-inch LCD, nice image stabilizer, and 3.4-megapixel still cam. Up to 10 hours of recording in low-quality mode.

↓ TIRED

Saves videos in a proprietary format, which converts to Windows ASF with Panasonic's software (no Mac compatibility).

Digital Video Cameras How We Tested

ALL CAMERAS



ZOOM

Setting the camera on a tripod, we zeroed in on a faraway Victorian building with intricate ornamentation. We expected crisp detail and color using each camera's maximum optical zoom setting.



IMAGE STABILIZATION

We ditched the tripod and reshot the same Victorian at maximum optical zoom while handholding the camera. High performers kept footage stable and didn't drop video detail.



ARTIFICIAL LIGHT

In a room illuminated only by two 75-watt incandescent bulbs, we shot a variety of footage to test the cams in suboptimal light.

ALL CAMERAS



ACTION SHOTS

Outdoor basketball games put the cams through their paces. The best delivered smooth motion video of the fast-moving action with quick autofocus.

MINIDV



COLOR AND WHITE BALANCE

Working indoors, we shot a brightly colored blanket lit by a 750-watt tungsten studio light with a color temperature of 3,200 K. All white balance settings were on auto. We were impressed if the cams captured four different shades of white, 3-D details of the fabric, and vivid reds and blues.



NOISE

We listened for tape noise during playback. Silence was golden.



◀ PANASONIC D-SNAP SV-AV50A

Trump style at apprentice prices. This ultrasmall 2-megapixel camera, MP3 player, and voice recorder had promise. Too bad its footage is shaky and its unique flip-out design encourages covering the lens with your fingers. Video quality is limited to 320 x 240. You're fired!

\$400, www.panasonic.com



↑ WIRED

Good video quality, but only when viewed on a computer. Great software package lets you edit and combine clips.

↓ TIRED

Saves video in proprietary format. No Mac compatibility. Comes with measly 8-Mbyte SD card.



◀ PHILIPS KEY019

For making spur-of-the-moment Web and email movies, this lilliputian cam is hard to beat. Plus, it has a built-in MP3 player. But at 320 x 240, its video footage is less than impressive. Worse, you're stuck with 128 Megs of built-in memory.

\$250, www.philipsusa.com



↑ WIRED

Teeny-tiny (2.1 ounces). USB port for charging and connectivity also lets it serve as a key chain drive for file storage.

↓ TIRED

Useless in low light. No zoom. Limited capacity. Records to Windows ASF format.



◀ SANYO FISHER FVD-C1

The winner of the beauty portion of our flash-based filmer test shot great video at a maximum resolution of 640 x 480. We also prefer its LCD and menu functions to those on other cams. Five custom autoexposure and ISO settings help it perform well in a variety of lighting conditions.

\$800, www.fisherav.com



↑ WIRED

Top performer in low light. 5.8X optical zoom. 3.2-megapixel stills. Saves to MPEG-4 format.

↓ TIRED

Video not as sharp as Panasonic SV-AV100 in hi-res mode. Swank colored models not available in US.

Digital Video Cameras Scorecard

	Rating	Model	Price	Dimensions (inches)	CCD Size (inches)	Optical Zoom	LCD Size (inches)
MINI DV	4.5	✓ Canon Optura Xi	\$1,500	3.2 x 3.5 x 7.9	0.29	11X	3.5
	4	Panasonic GS15	\$500	2.8 x 3.7 x 4.7	0.17	24X	2.5
	4	Sony DCR-HC65	\$800	2.4 x 3.5 x 6.5	0.2	10X	3.5
	3	JVC GR-DVP9US	\$1,300	3.2 x 1.8 x 4.6	0.25	10X	2
	2	Samsung DuoCam SC-D6040	\$900	2.5 x 3.6 x 5.4	0.17	10X	2.5
TAPELESS VIDEO	4.5	✓ Panasonic D-Snap SV-AV100	\$1,000	3.5 x 1.3 x 2.6	0.17	10X	2.5
	4	Sanyo Fisher FVD-C1	\$800	2.7 x 1.3 x 4.3	0.37	5.8X	1.5
	3	Philips Key019	\$250	1.3 x 3.8 x 0.9	0.5	None	None
	2	Panasonic D-Snap SV-AV50A	\$400	1.9 x 2.6 x 1.3	0.31	None	2
	0.5	Aiptek Pocket DV4500	\$150	3.9 x 2.6 x 1.3	N/A	None	1.5



VIDEO

High-Definition TVs

The visuals are the centerpiece of any home theater system. The best sets deliver razor-sharp detail, punchy colors, and smooth motion. **by Bob Parks**

- 57 **Plasma TVs**
- 59 **LCD TVs**
- 61 **Rear-Projection TVs**
- 62 **High-End Projectors**

PLUS:

- 66 **Budget Projectors**
- 67 **Widescreen PC Monitors**



High-Definition TV Essentials

CONSOLES ▼

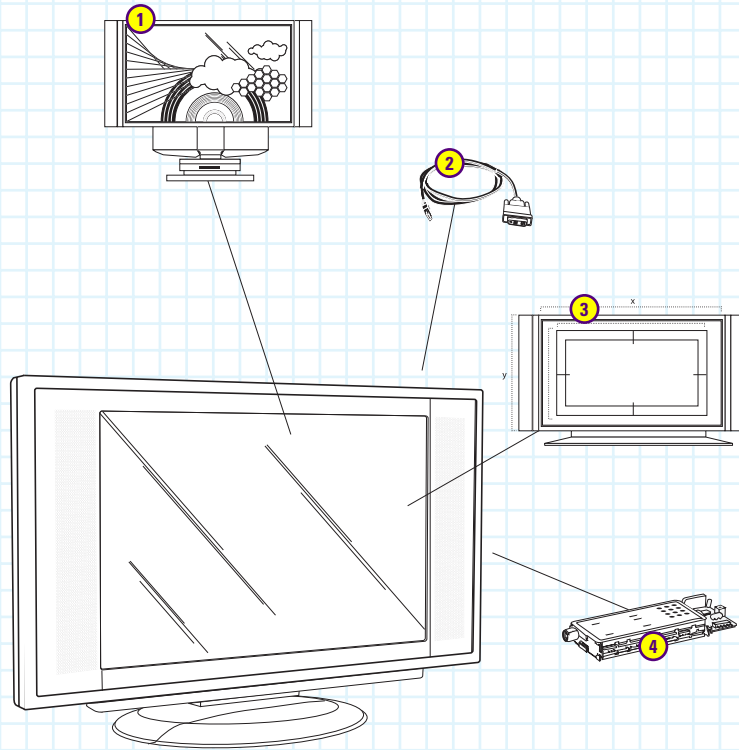

1 SCREEN TYPE

Console TVs employ various technologies to display similar – but subtly different – results. Plasmas use glowing phosphors energized by an electrically charged gas. LCDs transmit rays from a fluorescent backlight through color filters. And the latest rear-projection TVs use digital light processing (DLP) or liquid crystal on silicon (LCoS) chips to control how light is reflected onto the screen.

2 VIDEO CONNECTIONS

A digital connection, either DVI or HDMI, yields top quality. Next-best is an analog component hookup. TVs with VGA and certain types of DVI jacks can double as computer monitors.

3 RESOLUTION

An HDTV has 720 or more horizontal lines of pixels. Resolutions are often expressed in horizontal and vertical dimensions (e.g., 1,024 x 768); the second number is the more important one.

4 TUNERS

Most TVs pick up regular analog broadcasts with a built-in NTSC tuner (or sometimes two tuners, for picture-in-picture viewing). Some sets also have ATSC tuners for hi-def signals.

PROJECTORS ▼

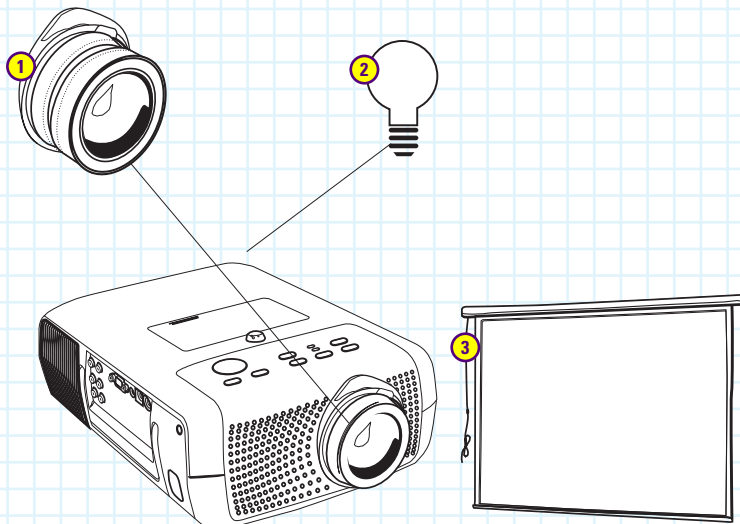

1 LENS

Many lenses zoom so you can adjust the image to fit your viewing area without moving the projector. Some models can be controlled via remote.

2 BRIGHTNESS AND CONTRAST

Light intensity is measured in lumens. A brightness of 800 lumens or more works well for home theater use. Contrast ratio is the difference in brightness between a pure white screen image and a pure black one. Look for a ratio of 1,000:1 or higher.

3 SCREEN

You can project on a wall, but a screen boosts contrast and reflects more light.

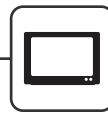

Plasma TVs

With fluid action and luminous picture quality, these thin wonderscreens rule for movies. But be careful with games – static images can burn in a ghostly imprint.

LESS THAN 50 INCHES ▼



◀ MARANTZ PD4240D (42-INCH)

Even subtle color variations are perfect on this screen, from the solid reds in the American flag on an evaluation disc to the pink on Rodney Dangerfield's head in an HD broadcast of the 1992 stinker *Ladybugs*. We saw more shadow detail in *The Piano* than on any other TV tested. Minor flaws included some graininess in clouds during *Mystic River* and in low-light scenes on Xbox games.

\$7,999, www.marantz.com



↑ WIRED

Among the best pictures available, with great detail, refined color, and inky blacks.

↓ TIRED

Splotchy colors in faces and moving objects. Sticky, poorly designed remote is so bad it might as well be disposable.



◀ PIONEER PDP-4340HD (43-INCH)

Pioneer's plasma was the kindest set to movies. It shows spot-on color, detail even in dark corners, and fluid movement. Most TVs use the reverse 3-2 pulldown method to display film (see Glossary, page 60), resulting in a slight stuttering effect. But Pioneer's 3-3 pulldown system makes film look as smooth as in a theater.

\$8,500, www.pioneerelectronics.com



↑ WIRED

Flawless for movies. Terrific HDTV color and detail. Clean, intuitive menu for settings and options.

↓ TIRED

There's still good TV on analog broadcasts, but the Pioneer displays it a bit more jagged than on other tested models.

50 INCHES AND UP ▼



◀ FUJITSU P50XHA30WS (50-INCH)

Before calibration, colors appear bright, and blacks are deep as pitch. With analog signals, it displays cleaner diagonals and text than other plasmas. But Fujitsu cheats by pumping up the contrast to make the image seem more impressive, leaving out detail in low-light scenes. After calibration, the screen displays noise in dark areas and doesn't make smooth color transitions.

\$8,999, www.us.fujitsu.com



↑ WIRED

Brilliant colors from both digital and analog signals made this TV fun to watch. Excellent at adapting standard-definition broadcasts to its huge screen.

↓ TIRED

Color transitions look patchy in shadows. Sad little remote with nubby rubber chicklet buttons.

QUICK TIP

Unlike LCD and projection sets, plasmas maintain high image quality from any viewing angle.

VIDEO
HIGH-DEFINITION TVs



◀ LG DU-50PZ60/H (50-INCH)

This TV's processor takes the common jitters out of DVD films – we saw amazingly fluid motion during the opener of *Star Trek: Insurrection*. But our other intergalactic test movie – *Lost in Space* – revealed pixels salsa-dancing on William Hurt's black suit. The screen also delivers inaccurate color and uneven tones in dark areas.

\$7,000, www.lge.com



↑ WIRED

Good price for this screen size. LED readouts on the remote and under the screen make navigation easy. Built-in tuners for both standard and HD television.

↓ TIRED

Annoying hum from the back of the console brings back memories of Grandpa's old set.

SPLURGE



◀ NEC PX61XM2/S (61-INCH)

This 5-foot billboard is among the most accurate sets for color, showing rich red and green hues in our test with the Uma Thurman flick *The Golden Bowl*. In one subtle way, however, the display slips with some false contouring, in which a moving object takes on patchy colors rather than smooth gradations.

\$13,995, www.necvisualsystems.com



↑ WIRED

Quality image with natural colors and true blacks. Exhaustive menus allow multiple adjustments, such as control over secondary colors and gamma (midtone brightness).

↓ TIRED

No TV tuner – you need to get an external box.

High-Definition TVs How We Tested



CALIBRATION

We calibrated the televisions using the basic patterns on the Avia Pro diagnostic DVD. The digital source was a Bravo D2 DVD player with a DVI connection. When necessary, a DVI-to-HDMI adapter from Monster Cable was used.



MOTION

To further test motion processing, we switched the Bravo DVD player's output to 480-line interlaced over an analog component cable and gauged the ability of the TV's processor to deinterlace video using Avia's film-to-video transition and motion dither tests.

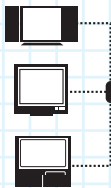

DIGITAL MOVIES

To examine detail, black levels, and color, we watched *Mystic River*, *Lost in Space*, and *The Golden Bowl* on all the sets. A few other films came and went, but these three movies ran on all our test screens for comparison. By running the DVI source through a Gefen 2:8 HDTV Distribution Amplifier, we were able to evaluate several TVs simultaneously.

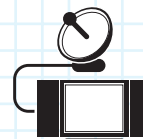

HD AND STANDARD TV

Our HDTV came courtesy of Voom satellite service and Adelphia HD cable. We watched standard analog TV from Adelphia by threading a coaxial cable wire to each TV's NTSC tuner.

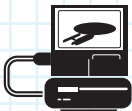

ANALOG MOVIES

Though a digital signal offers the best image quality, very few DVD players have a digital output. So we tested each TV's analog capabilities (including the ability to process motion) by watching *Star Trek: Insurrection* through the component outputs of the Bravo DVD player.



GAMES

We played a few rounds of the standard-def game *Driv3r* on the Xbox using component inputs.



PROJECTION

For front projectors, we shot onto a 45 x 80-inch Da-Lite Cinema Contour HDTV home theater screen. Casual visitors mistook the results for an enormous plasma television. Amateurs.



LCD TVs

LCDs aren't just for the kitchen anymore – they now come in jumbo sizes. And their deep blacks and improved motion rendering are approaching plasma quality.

LESS THAN 40 INCHES ▼



◀ BENQ DV3070 (30-INCH)

The DV3070 features a stunning design and intuitive controls but mediocre performance. It displayed bands of color rather than smooth tonal transitions. The opening of *Mystic River*, which should have been a clean, slow fade-up from black, looked blotchy and uneven. (BenQ acknowledges the problem and says it will be fixed in the 2005 model.)

\$2,995, www.benq.com



↑ WIRED

Easy to use. Standard TV clear and detailed. Sleek style would look perfect in a swank apartment.

↓ TIRED

Color attenuated in film and TV (the roses in the White House garden had an orange cast). Low-light scenes on film and HDTV were distorted and patchy.



◀ SHARP LC-37G4U (37-INCH)

Color is fantastic on Sharp's LCD. In *Mystic River*, it perfectly captured the full, somber tones of South Boston. This screen also scored highest for detail in our Kevin Bacon freckle test. It displayed the most dots on his face, along with the creases in his forehead and below his eyes. But analog TV looked slightly grainy.

\$5,500, www.sharpusa.com



↑ WIRED

Colors vibrant as a Dutch flower boat. Flawless image quality for film and HDTV. Optical picture control adjusts image to match room lighting.

↓ TIRED

Middling performance with analog TV. Very slight digital noise in the shadow areas of film.



◀ TOSHIBA 32HL84 (32-INCH)

Like a decathlete, this Toshiba performs well in all events. It brought a tight, sharp look to the action of *Lost in Space* (although a few scenes showed some color banding instead of a smooth transition to black). It also displayed spectacular analog TV and didn't exhibit any shimmer in the razor-thin lines of Voom's nightly HDNews; its image processor works overtime to groom scenes perfectly.

\$3,499, www.toshiba.com



↑ WIRED

Films appear smooth and detailed. Picture-in-picture feature not only displays two signals, but can also freeze-frame seven other stations.

↓ TIRED

Blacks a bit gray. Color and contrast not as strong as on the bigger flat panels. At 5 inches, an inch thicker than the larger-screened Sony.

Coming Tech: LED Backlights

Ultrapure white light will expand the color palette of LCD TVs.

In spring 2005, the US should get its first look at LCD sets that use LEDs, rather than fluorescent tubes, as backlights. Sony's Qualia 40- and 46-inch LCD TVs (now out in Japan) incorporate new LEDs from Lumileds to display a fuller range of colors.

Sony's LED-based LCDs use hundreds of tiny red, green, and blue lamps as backlights, mixing the three colors into a far purer white light than produced by typical fluorescent-lit

units and feeding it to better color filters in the pixels. Lumileds claims the LED sets display up to 30 percent more saturated and vivid colors than CRT and plasma TVs. That will add pop to DVDs, and the Sony models have memory card slots for also showing off digipics in a wider range of hues than on a typical monitor. Lumileds says it's working with several other, unnamed companies to include its technology in their 2005 TV models. – B.P.

MORE THAN 40 INCHES ▼



◀ SAMSUNG LT-P468W (46-INCH)

This whopper's superhigh resolution displays all 1,080 lines of the top HD format. (Most flat panels squish them into 720 or 768 lines.) Heavy black tones captured the loneliness of space, while punchy colors and contrast complemented bright scenes. But it fails to show gradual transitions of color in some DVD film scenes.

\$9,999, www.samsungusa.com



↑ WIRED

1,920 x 1,080-pixel resolution. Bright image. DVI and HDMI inputs.

↓ TIRED

Dark grays are coarse. Subtle colors abut unevenly – especially with digital input. Lacking a wide range of shades, images don't have much depth.



◀ SONY KDL-42XBR950 (42-INCH)

The do-it-all, giant LCD has arrived. Facial details and skin tones were lifelike in the Chris Rock comedy *Head of State*. The Cartoon Network's *Aqua Teen Hunger Force* startled us with arresting color. And Xbox games appeared three-dimensional. Although the Sony smooths out film well, we still prefer the more fluid look of plasma.

\$10,000, www.sonystyle.com



↑ WIRED

Built-in HDTV tuner. Memory Stick slot for loading JPEG photos, MPEG-1 videos, and MP3 audio. Slick silver metallic remote.

↓ TIRED

Won't save unique settings for each source – you can't custom-calibrate for your DVD player and HDTV signal, for example.

Glossary: The ABCs of HDTV

Here's the jargon you should know before you make that big purchase.

480i A format for VHS, DVD, and regular analog broadcasts that shows images with 480 lines in an interlaced pattern.

480p A format used for some television broadcasts and created by progressive scan DVD players from 480i discs. It's often called enhanced definition. A small number of televisions show 480p, but not 720p or 1,080i, positioning them in a purgatory between the standard and HD worlds.

720p One of two high-definition formats; shows images with 720 lines displayed progressively (all at once).

1,080i The other high-definition format. It displays images with 1,080 lines in an interlaced manner. Since few HDTV screens have 1,080 lines, the format is often converted to 720 or 768 lines without an obvious difference.

ATSC The technical specification for high-definition formats – 720p and 1,080i – as well as the enhanced-def 480p format.

HD High definition describes any television or videostream using a 720p or 1,080i format. Other features are a widescreen (16:9) aspect ratio and support for Dolby 5.1 surround sound.

Interlaced To save bandwidth, many TVs receive only half an image at once. The screen flicks 60 times per second

between the odd- and even-numbered lines of an image. Because they flash so quickly, these sets of interlaced lines (called fields) appear to the viewer as full screens.

NTSC The technical specification for analog broadcasts in the 480i format, along with signals from a VHS or non-progressive-scan DVD player.

Progressive When a TV displays a progressive image, it flashes the entire video frame 60 times per second. The main progressive formats are 480p (DVDs and enhanced-definition TV broadcasts) and 720p (hi-def TV). Showing all the lines at the same time yields more fluid motion-rendering.

Reverse 3-2 Pulldown When movies are released on DVD, film (which runs at 24 fps) is transferred to video (which runs at 60 half-frames, or fields, per second). Making the formats mathematically compatible requires a so-called 3-2 pull-down process that leads to some choppiness and image distortion. Reverse 3-2 pull-down analyzes incoming video and reassembles it to ensure sharp images and smooth motion onscreen.

SD Standard definition describes any TV set or videostream that uses the 480i format. – B.P.

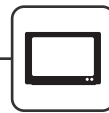

Rear-Projection TVs

The best value in HDTV, rear-projection sets offer bold color and giant screens. But they're behemoths and can be too dim for bright rooms.



◀ JVC HD-52Z575 (52-INCH LCoS)

The three-chip LCoS system on this JVC projects red, green, and blue light simultaneously, yielding a bright image free of the rainbow effect of color-wheel TVs. But we saw multicolored shimmers in the gray pavement during *Mystic River*, and a reverse 3-2 pulldown glitch caused a hazy, flickering image on the *Star Trek: Insurrection* DVD. **\$4,500, www.jvc.com**



↑ WIRED

Brightest image with the blackest blacks of any rear-projection model tested. Solid colors with no rainbow effect.

↓ TIRED

Not for cinephiles – bad 3-2 pulldown detection on analog inputs.



◀ MITSUBISHI WD-52525 (52-INCH DLP)

While all three DLPs use Texas Instruments' patented tech, Mitsubishi's clever image processing delivered especially clear action and accurate color in epics such as *Master and Commander*, with sea spray so detailed we reached for the Dramamine. A glass screen filter yields deep blacks but also catches glare from room lights. **\$3,999, www.mitsubishi-tv.com**



↑ WIRED

Rich, realistic color and fine details. NetCommand feature controls linked gadgets like DVD players, DVHS recorders, and satellite boxes from the TV screen.

↓ TIRED

Slight distortion in dark parts of films. Some fan noise.



◀ OPTOMA RD65 (65-INCH DLP)

This bright screen could replace the Jumbotron at Fenway. In fact, it shined with one of the season's Yankees-Red Sox debacles, showing standard-def vividly in a well-lit room. But it doesn't fare well with films and general color reproduction. Hues appeared washed out in *Mystic River*, and even Boston's Green Monster looked pale. **\$4,995, www.optomausa.com**



↑ WIRED

Most brilliant screen of the DLPs. A pair of standard-def tuners and simple menus make it easy to monitor dueling sports contests.

↓ TIRED

Loudest fan noise of all the TVs, but quieter than an average fridge.



◀ V INC. VIZIO RP56 (56-INCH DLP)

Vizio may be a cheap date, but it's a lot of fun to hang with. It displayed convincing, dense colors with our evaluation movies. Games for Xbox also looked good, and it's easy to hook up thanks to front-panel composite and S-video jacks. Caveat: The screen was the dimmest of all products we tried (though only slightly worse than other DLP models). **\$3,299, www.vinc.com**



↑ WIRED

Rich color, especially reds. Quieter than its peers. Comes with two remotes – one with full controls and one just for picture-in-picture – so warring mates can channel surf on the same telly.

↓ TIRED

Details murky in dark scenes.

High-End Projectors

True home theater has arrived. DLP-based projectors beam fast action sequences and fine detail at up to 22 feet across. You'll be selling tickets to your living room.



◀ INFOCUS SCREENPLAY 7205

This 9.5-pound wonder provides a great traveling show. It made a red sports car appear to leap off the screen in a sequence from *Seabiscuit*—while showing vivid green hills in the background. Distortion and coarse tones plagued darker scenes in the same film, however, as did color noise during a hi-def broadcast of a Morcheeba concert.

\$8,999, www.infocus.com



↑ WIRED

Lightweight and portable. Striking, appropriate color and very smooth motion. Intuitive remote.

↓ TIRED

Noisy, with a slight whine. Dancing pixels and uneven color surfaces in shadows, especially videogames and HDTV.



◀ OPTOMA H77

The boxy H77 beamed solid, true colors during a viewing of *The Golden Bowl*—with deep reds in Uma Thurman's lips and iridescent greens in her peacock fan. But flesh tones aren't as true-to-life as with the other projectors, even after we made adjustments—the geeky newscaster on Voom HDTV news looked more peaked than usual.

\$8,999, www.optomusa.com



↑ WIRED

Quietest unit we tried. Good detail. Well-designed lens housing makes it easy to shift up and down, focus, and zoom at the touch of a button.

↓ TIRED

Slight blotchiness in dark scenes. Screen goes blank briefly when you change channels.



◀ SHARP XV-Z12000

The Sharp renders brilliant color and fine detail in fast-moving action sequences. The *Lost in Space* footage was crisp, and the projector perfectly rendered Jim Carrey's synesthetic world in *Eternal Sunshine of the Spotless Mind*. In HDTV, subtle details and deep blacks captured the noirish atmosphere of shows like *Law and Order*.

\$12,000, www.sharpusa.com



↑ WIRED

Brightest picture. Incredible detail gives objects dimension. The 32.5- to 44-mm lens offers the widest image range—from poster- to building-sized.

↓ TIRED

Small degree of distorted color in low-lit scenes.

Why Are These Projectors So Expensive?

Better image chips and display technology add up—in both cost and picture quality.

All DLP front projectors (and rear-projection TVs) use Texas Instruments image chips, but the pricier models in our test have TI's latest HD2+ imager. Its micromirrors carry larger reflective surfaces, creating a brighter image, and can better reflect light away from the lens for darker blacks onscreen.

The high-end projectors also use a seven- or eight-segment

color wheel that spins faster than those on basic models, so you're less likely to see the individual pulses of red, green, and blue light, an aberration called the "rainbow effect." Although affordable units have improved considerably (see Budget Projectors, page 66), cinephiles will appreciate the benefits of these more expensive technologies. — B.P.



Coming Tech: Organic LED Screens

Press Control-P to print your new television.

Despite their virtues, LCD and plasma panels have significant vices. LCD has limited viewing angles, plasma gorges on electricity, and both are expensive to produce. Switching from these technologies to organic LEDs could fix all these problems.

The chemicals in OLEDs glow brightly when they receive a slight electric charge. And screens made of them have as wide a viewing angle as plasma panels. Now Seiko Epson has created a method that aims to produce OLED screens in almost any size at little cost. The companies are using an inkjet process to deposit the polymers in a precise design

on a backboard. Prototype displays have been printed at up to 40 inches.

But it wasn't as easy as substituting OLED for pigment. The company had to develop inkjet nozzles controlled by piezoelectric valves instead of heat, which would damage the organic compounds.

Seiko Epson is eager to start printing reams of HDTVs by 2007, but it must find a way to make them last longer. While typical plasma televisions lose half their brightness after 30,000 hours of use, OLEDs fade that much in approximately 2,000 hours. — B.P.

High-Definition TVs Scorecard

	Rating	Model	Price	Screen Size (diagonal)	Resolution	Dimensions (H x W x D / weight)	Built-In TV Tuners	High-Definition Inputs
PLASMA	5	✓ Pioneer PDP-4340HD	\$8,500	43 inches	1,024 x 768	25.7 x 44.1 x 3.9 inches, 67.3 lbs.	2 NTSC, 2 ATSC	2 HDMI, 3 sets component
	4	Marantz PD4240D	\$7,999	42 inches	1,024 x 768	24 x 40 x 3.5 inches, 65 lbs.	None	DVI, component
	4	NEC PX61XM2/S	\$13,995	61 inches	1,365 x 768	34.6 x 57.9 x 4.7 inches, 134.2 lbs.	None	DVI, component
	3	Fujitsu P50XHA30WS	\$8,999	50 inches	1,366 x 768	28.7 x 47.8 x 3.9 inches, 99.2 lbs.	None	DVI, 2 sets component
	2	LG DU-50PZ60/H	\$7,000	50 inches	1,366 x 768	30.6 x 48.2 x 3.9 inches, 114 lbs.	2 NTSC, ATSC	DVI, 2 sets component
LCD	4.5	✓ Sharp LC-37G4U	\$5,500	37 inches	1,366 x 768	21.6 x 43.4 x 3.5 inches, 43 lbs.	NTSC	HDMI, DVI, 2 sets component
	4	Sony KDL-42XBR950	\$10,000	42 inches	1,366 x 768	27.4 x 53.1 x 4.1 inches, 66.3 lbs.	2 NTSC, ATSC	DVI, 2 sets component
	3.5	Toshiba 32HL84	\$3,499	32 inches	1,366 x 768	22.6 x 32.3 x 5 inches, 53 lbs.	NTSC	DVI, 2 sets component
	3	Samsung LT-P468W	\$9,999	46 inches	1,920 x 1,080	27.1 x 54.1 x 5.7 inches, 99.2 lbs.	2 NTSC	HDMI, DVI, 2 sets component
	2	BenQ DV3070	\$2,995	30 inches	1,280 x 768	20.8 x 36.3 x 8 inches, 35.6 lbs.	NTSC	HDMI, 2 sets component
REAR-PROJECTION	4.5	✓ Mitsubishi WD-52525	\$3,999	52 inches	1,280 x 720	37.2 x 49.6 x 17.4 inches, 132.4 lbs.	NTSC, ATSC	HDMI, 2 sets component
	4	V Inc. Vizio RP56	\$3,299	56 inches	1,280 x 720	43.1 x 54.4 x 18.9 inches, 130 lbs.	2 NTSC	DVI, 2 sets component
	3	JVC HD-52Z575	\$4,500	52 inches	1,280 x 720	36 x 49.9 x 16.3 inches, 84 lbs.	NTSC	HDMI, 2 sets component
	3	Optoma RD65	\$4,995	65 inches	1,280 x 720	51.7 x 59.5 x 22 inches, 215 lbs.	2 NTSC	DVI, component
HIGH-END PROJECTORS	4	✓ Sharp XV-Z12000	\$12,000	Up to 25 feet	1,280 x 720	7 x 18.7 x 16 inches, 20.7 lbs.	None	DVI, 2 sets component
	3.5	Optoma H77	\$8,999	Up to 25 feet	1,280 x 720	5.3 x 16.9 x 12 inches, 16.5 lbs.	None	DVI, component
	3	InFocus ScreenPlay 7205	\$8,999	Up to 11.5 feet	1,280 x 720	4.3 x 13.8 x 12.8 inches, 9.5 lbs.	None	DVI, 2 sets component

Budget Projectors

Sick of your tube telly but too poor for plasma? Affordable DLP projectors let you big up *Da Ali G Show* without stuffing your living room with a big box. – **Thomas Goetz**

OPTOMA H30 SHOWN

Despite its plain design, the H30 outshines the others with razor sharp images, deep blacks, and elegant onscreen controls. It makes the most of its 800 lumens, with the warmest, most vivid picture of the low-cost projectors we looked at. It's also simple to use, handily switching from standard TV to widescreen mode. One gripe: Resolution is low at 800 x 600 (the others measure 1,024 x 768).

\$1,499, www.optoma.com



INFOCUS SCREENPLAY 4805

InFocus' lower-end ScreenPlay rivals the Optoma for image quality. Its rich colors impressed – including deep blues and reds – but the unit puts out less light than we'd like. It's better equipped than our pick, however, with 1,024 x 768 resolution, plus hi-def component and DVI inputs.

\$1,499, www.infocus.com

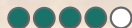

BENQ PB6200

Once cutting-edge, BenQ's budget DLP now lags behind: The PB6200 is less vibrant than other models, with washed-out reds, and it lacks high-definition component video inputs. But it's bright enough to use even with some ambient light, and the preset Video, Vivid, and Economy modes are handy.

\$1,599, www.benq.com

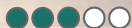

NEC LT10

The punchy little LT10 is 7.8 inches wide and 2.1 pounds, but it throws a big, bright picture on your wall or screen. Meant for the boardroom, it does the job in the living room too, with a few compromises: The fan whines, and there's no economy mode. Plus, the lamp is rated at 2,000 hours (the others claim 3,000).

\$1,795, www.necsam.com





Widescreen PC Monitors

CRTs are for squares. Widescreen LCDs turn even casual photo editing into a cinematic event and display DVDs in full 16:9 glory. A couple of these 23-inchers even do TV. – **M. David Stone**

SONY SDM-P234

Sony's LCD delivers fine gradation with bright colors. It does a great job converting VGA to digital, adjusting the analog signal to lock in crispness. Advanced image controls include gamma response and color temperature presets, while adjusting the screen's swivel and tilt is effortless.

\$2,000, www.sonystyle.com

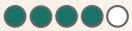

APPLE CINEMA HD DISPLAY

The Cinema HD is a top performer when it comes to image quality, and it just beats out the others in subtle shading of bright colors. Using the tilt feature is a kinesthetic joy – the panel has an Olympic gymnast's balance. But there's no VGA input, so you can't connect most laptops.

\$1,999, www.apple.com



PHILIPS BRILLIANCE 230W5

Though it looks like a concept model from decades past, this LCD doubles as a high-definition TV screen. Unfortunately, it has a bit more pixel jitter than other models that accept analog input. An integrated 8-in-1 memory card reader lets you send digicam images to your PC via USB.

\$2,399, www.philipsusa.com



HP F2304 HD LCD **SHOWN**

No matter what's on display, this HP screen is hard to ignore. Digital DVI and analog D-sub connectors take your PC's output, while S-video and component video jacks handle everything from a DVD player to a TV tuner. Image quality is superb whatever the source. The built-in speakers offer ample sound, and the picture-in-picture feature gives you the luxury of watching TV or video in a small window while checking email or surfing the Web on the rest of the screen.

\$2,199, www.hp.com

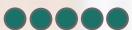



VIDEO

Digital Video Recorders

Kick your VHS machine to the curb. DVRs are easier to use, deliver a better picture, and find your favorite shows for you. **by Brian Lam**

- 71 **High-Definition DVRs**
- 72 **Standard-Definition DVRs**
- 74 **DVD-Burning DVRs**

PLUS:

- 76 **DVD Rental by Mail**
- 77 **Movies-On-Demand**



Digital Video Recorder Essentials

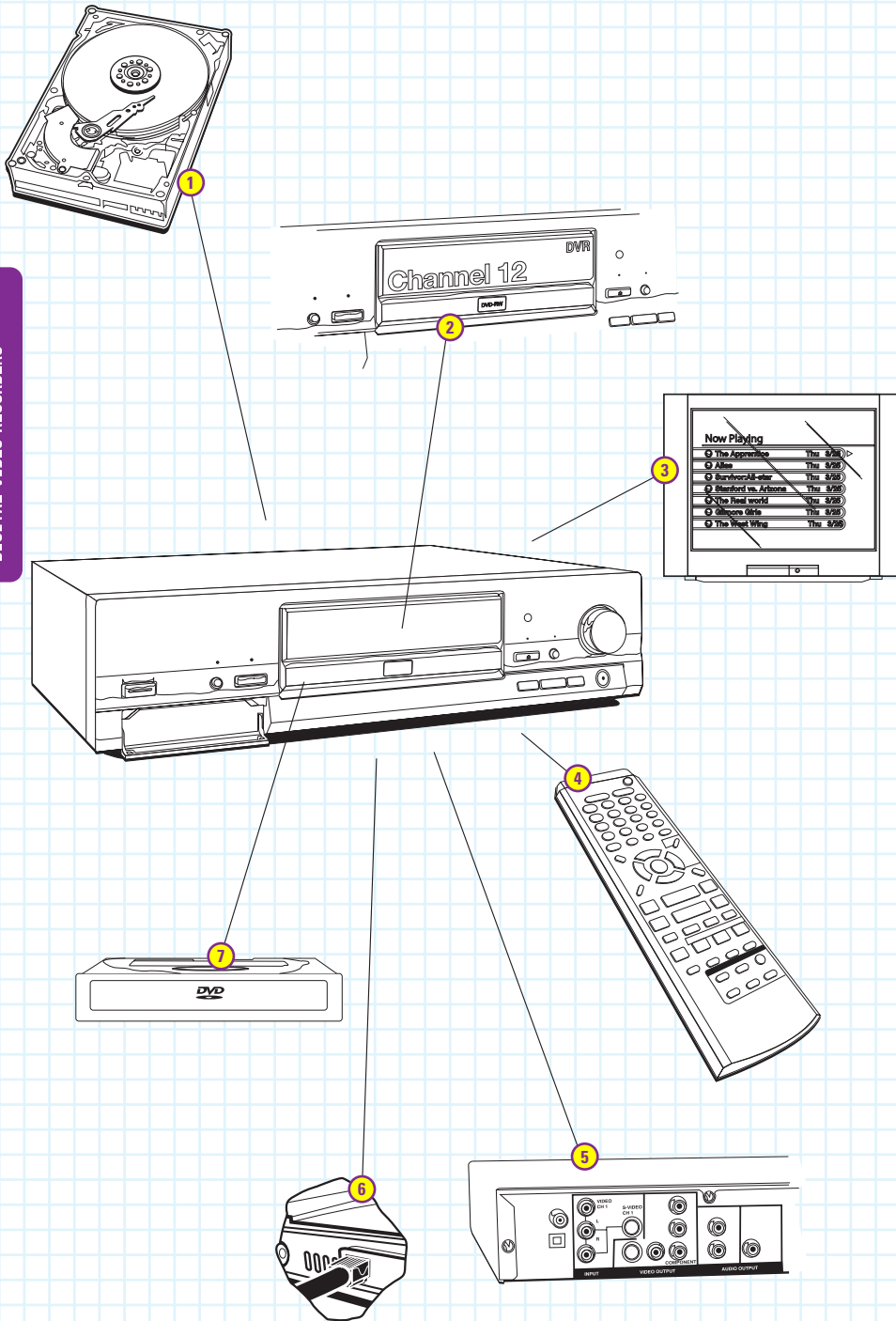

1 STORAGE

DVR capacities range from 40 to more than 300 gigs. Sixty minutes of standard-definition programming requires roughly 1 gig, an hour of high-definition about 8 gigs.

2 TUNERS

Most boxes have standard TV tuners equipped for rabbit ears or analog cable. Branded DVRs from Comcast, DirecTV, and Dish Network can handle those services' higher-quality digital signals.

3 INTERFACE AND LISTINGS

Specs like hard disk space, inputs, and sharing are important, but user experience matters most. Program guides – the grids of channels and shows your DVR downloads from a listing service – should scroll quickly and be easily scannable.

4 REMOTE CONTROL

The remote should fit comfortably in your hand, with the most frequently used buttons – like channel and volume – directly under your thumb.

5 CONNECTIONS

High-quality outputs ensure a crisp, clear picture. Coaxial and composite video aren't as good as S-video. Analog component video and HDMI – which support progressive-scan DVDs and HDTV – are the best choices.

6 NETWORKING

Some DVRs let you swap shows with other DVRs, or share them with a PC, using an Ethernet or Wi-Fi network. A few support remote scheduling via the Web.

7 DVD BURNER

Some machines come with a burner for archiving programs, home videos, and slideshows. DVD-R and DVD+R discs are compatible with most players.

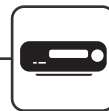

High-Definition DVRs

If you shelled out for an HDTV, only a hi-def recorder will do. Most are integrated into a cable or satellite box, which makes setup easy – but ties you to one service.

CHEAP THRILL



◀ COMCAST/MOTOROLA DCT6208

At 80 gigs, the hard drive holds only 10 hours of HDTV. And the myopic guide displays a mere hour of programming per screen. But the price is nice: Instead of plunking down a grand for the device, you rent it for about \$10 per month (the fee is added to your cable bill). A bargain – if Comcast serves your area.

\$10-13 per month, www.motorola.com



↑ WIRED

Well-designed remote. Setting up recordings is hassle-free, and you can search for shows by title.

↓ TIRED

Single tuner – you can't record a show while watching another channel. Low storage. No dubbing by keyword.

EDITORS' PICK



◀ DIRECTV HD DVR

This unit combines three of the best lounge-chair technologies out there: high-definition, hundreds of DirecTV channels, and TiVo's legendary remote and interface. Dual sat and over-the-air HD tuners can pack the 250-Gbyte drive with up to 30 hours of hi-def shows. Alas, DirecTV hasn't activated remote scheduling, and TiVo's guide is sluggish.

\$999, www.directv.com



↑ WIRED

TiVo remote and interface. HDMI carries digital video and audio through a single cable. Can record two programs while playing a third from the hard drive.

↓ TIRED

Doesn't support picture-in-picture. Remote scheduling disabled.



◀ DISH PLAYER-DVR 921

This Dish Network set-top supports picture-in-picture, so you can watch dueling episodes and *Law & Order* and *CSI: New York* on one screen. But the interface and guide are a little homely, and despite having the same 250 gigs of hard drive space, the device stores only 25 hours of hi-def programming.

\$999, www.dishnetwork.com



↑ WIRED

Includes three HD tuners: two satellite, one broadcast. DVI and component outputs.

↓ TIRED

Recurring shows can only be scheduled by time – not by title. Remote suffered interference.



◀ LG LST-3410A

The LG is the only high-definition DVR we tested that isn't linked to a cable or satellite service. Its integrated tuner gets HD content from – and only from – the local airwaves. Program listings come through a clumsy TV Guide interface, which forces you to manually map programs to channel numbers.

\$1,000, www.lge.com



↑ WIRED

HD reception and recording with no cable or satellite fees. FireWire hookup for recording from a DV cam. Handy thumbnails of saved content.

↓ TIRED

Only a handful of stations currently broadcast in HD. 120-Gbyte drive holds just 12.5 hours of hi-def.

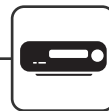

Standard-Definition DVRs

They won't fill widescreen HDTVs with hi-res images, but these recorders mean you're always just a few clicks away from your favorite shows.

◀ DISH PLAYER-DVR 510

Dish's standard-definition satellite-receiver-DVR combo stores up to 100 hours of shows on its 120-Gbyte hard drive. Like other integrated models, it records in pure digital. But the 510 doesn't support keyword recording (by director, by actor), and channel surfers will be frustrated by the guide's 1.5 hours of programming per screen.

\$299, plus \$5 per month, www.dishnetwork.com



↑ WIRED

All-digital recording. Phone jack for displaying caller ID info on TV. New Dish subscribers get box for free.

↓ TIRED

Onscreen guide makes finding programs tedious. Recording options limited. Single tuner (dual model is on the way).



◀ INTERACT-TV TELLY MC800 (40 GBYTE)

This Linux-based powerhouse records TV, plays and rips CDs, and serves media to your TV or any PC on your home network. It even records full DVDs to its hard drive – a boon for backing up copy-protected Blockbuster rentals. But the guide and menu navigation are far from refined.

\$699, www.interact-tv.com



↑ WIRED

Shares media with any computer on your network. No service fees.

↓ TIRED

Pricy. Remote scheduling feature requires you to log onto your home network.



◀ REPLAYTV 5504

Remote scheduling, keyword searches, handy one-touch recording – the 5504 does everything a DVR should. Also onboard is ShowNav, a button-based redo of the automatic ad-skipping feature that got ReplayTV into hot water a few years ago. And to top it off, the picture here is by far the sharpest of the non-hi-def lot.

\$150, plus \$13 per month, www.replaytv.com



↑ WIRED

Component video and digital audio outputs. Ethernet port. Multiple units can share content and recording duties. Quick guide scrolling.

↓ TIRED

Remote and menus not quite as elegant as TiVo's, making ReplayTV slightly harder to use.



◀ TIVO SERIES2 DVR (80 GBYTE)

TiVo's interface is pure pleasure, with clean menus and easy navigation via the remote's thumbpad. The guide is prodigious, giving you hours of program listings at a glance. And few DVRs can match TiVo's keyword searching, season passes that catch every episode of a show, and remote scheduling.

\$299, plus \$13 per month, www.tivo.com



↑ WIRED

Multiple TiVo's can share content over home network. Great interface and remote. Powerful recording filters.

↓ TIRED

USB adapter required for sharing. Sluggish guide scrolling.



DVD-Burning DVRs

Even the **biggest** hard drive can't store every *Simpsons* episode. A DVD-burning model lets you commit it all to memory. Your only limit: Shelf space.

◀ PANASONIC DMR-E95H



This **imaging freak's** dream can grab pictures from SD and CF flash memory with its built-in card readers. Dubbing video from the hard drive to DVD (and vice versa for non-copy-protected discs) is no problem. But the TV Guide scheduler doesn't automatically match program information to channel number, making recording tedious.

\$800, www.panasonic.com



↑ WIRED

Plays DVD-Audio discs. Easy-to-use remote. Simple video clip editing. Front FireWire port. Dual-layer DVD-RAM drive records up to 16 hours per disc, and 160-Gbyte hard drive stores 284 hours of video.

↓ TIRED

TV Guide scheduler almost useless. Doesn't provide seamless pausing and replaying of live TV, à la TiVo.

◀ PIONEER DVR-810H



With a **TiVo** operating system, this is the only DVD writer for true couch potatoes. It offers all of TiVo's service perks, including remote scheduling, and takes the mystery out of burning with a nifty pie-chart view of a disc's capacity as you load it up with shows. You can't rip flicks to the hard drive, though, and home-movie buffs are forced to go analog when importing digicam footage.

\$499, plus \$13 per month, www.pioneerelectronics.com



↑ WIRED

TiVo service and remote control features. Stores up to six hours of video per disc. Can burn a DVD while recording TV and playing a show from its 80-Gbyte hard drive.

↓ TIRED

No FireWire for DV cams. Can't edit shows before burning. Hard drive capacity limited to 80 hours.

◀ TOSHIBA RD-XS32



The **RD-XS32's** remote and menus were mind-numbingly complex – think graphing calculators and clocks on old VCRs. Plus, it uses the lame TV Guide system that requires manual matching of show info to channel numbers. We expected more from Toshiba.

\$500, www.toshiba.com



↑ WIRED

Onboard editing tools. Rips non-copy-protected DVDs.

↓ TIRED

Byzantine controls. Setting record quality is confusing.

QUICK TIP

If you're shopping for a DVR, you might want to consider a Media Center PC instead (see page 136).

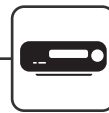

Building a Better DVR

Instead of idly waiting for the perfect one to appear, we propose this recipe.

Interface: Moxi

We love the screw-the-manual ease of TiVo's menus and controls, but we've seen better. Moxi by Digeo has a slicker UI, and it's lightning fast (unlike TiVo). At press time, Moxi was being tested in more than 50 cable markets in seven states.

Burner: Blu-Ray

DVD burning is the best way to archive TV shows. Current discs hold up to eight hours of standard-definition TV but not a minute of HD – the formats don't match. Blu-Ray recorders, available in Japan, store more than two hours of hi-def per disc.

Compression: MPEG-4

Hard drives and DVDs will hold even more HDTV when we ditch the MPEG-2 video-compression standard (requiring 8 to 10 gigs per hour) for this leaner codec.

Connection: CableCard Slot

Currently you're stuck using a branded DVR from your cable or satellite company or wiring up your tuner box through inferior analog ports. CableCard slots will allow a DVR to act as a decoder for any subscription service, even multiple services. That means fewer cables, video that hits your hard drive without lossy D/A conversion, and the ability to record several programs simultaneously.

Networking: Microsoft Media Center 2005

Some DVRs can be linked together to share content over a network, but what about your movie and music collections? The solution: a media motherbrain that stores your favorite shows, DVDs, and MP3s in a single location, and doles them out to slave boxes around the house. Microsoft's Media Center 2005 can connect a Media Center PC to a TV through a Media Center Extender (see page 137). Because there's more to life than *The Apprentice*. – B.L.

Digital Video Recorders Scorecard

	Rating	Model	Price	Capacity (Gbytes)	Listings Service	Inputs	Outputs	Additional Features
HIGH-DEFINITION	5	✔ DirecTV HD DVR	\$999	250	TiVo	Antenna, satellite	HDMI, component, S-video, composite video; optical, RCA audio	Great TiVo interface, HDMI-to-DVI cable included
	4	Dish Player-DVR 921	\$999	250	Dish Network	Antenna, satellite, composite video	DVI, component, S-video, coaxial, composite video; optical, RCA audio	Picture-in-picture, dual HD tuners, RF remote, USB port
	3.5	Comcast/Motorola DCT6208	\$10-13/month	80	Comcast	Cable, FireWire, composite video	DVI, component, S-video, coaxial, composite video; optical, RCA audio	Rentable, so it's a bargain; Ethernet and USB ports
	2.5	LG LST-3410A	\$1,000	120	Gemstar	Antenna, FireWire, composite video	DVI, component, S-video, RGB, composite video; optical, RCA audio	No cable or satellite service required
STANDARD-DEFINITION	4.5	✔ TiVo Series 2 DVR	\$299	80	TiVo	Antenna, cable, sat., S-video, composite video	S-video, coaxial, composite video; RCA audio	Best interface, USB port, remote scheduling
	4	ReplayTV 5504	\$150	40	ReplayTV	Antenna, cable, satellite, S-video, composite video	Component, S-video, coaxial, composite video; optical, RCA audio	Progressive video output, remote scheduling, Ethernet and USB ports
	3.5	Interact-TV Telly MC800	\$699	40	Interact-TV	Antenna, cable, satellite, FireWire, S-video, composite video	S-video, SVGA, composite video; coaxial, RCA audio	Rips CDs and DVDs, remote scheduling, Ethernet and USB ports
	3	Dish Player-DVR 510	\$299	120	Dish Network	Antenna, satellite	S-video, composite video; optical, RCA audio	Displays caller ID info on TV
DVD-BURNING	4	✔ Pioneer DVR-810H	\$499	80	TiVo	Antenna, cable, satellite, S-video, composite video	Component, S-video, coaxial, composite video; optical, RCA audio	DVD burning via TiVo interface, no fee for basic TiVo service, USB
	3.5	Panasonic DMR-E95H	\$800	160	Gemstar	Antenna, cable, satellite, FireWire, S-video, composite video	Component, S-video, composite video; optical, RCA audio	DVD-Audio support, flash-memory readers, PC card slot
	2.5	Toshiba RD-XS32	\$500	80	Gemstar	Antenna, cable, satellite, FireWire, S-video, composite video	Component, S-video, coaxial, composite video; optical, RCA audio	Front inputs for camcorders, rips unprotected DVDs

DVD Rental by Mail

Stop spending Saturday nights stalking your video shop's barren shelves. DVD-by-mail services offer thousands of titles – and no late fees. – **Kari Lynn Dean**



◀ BLOCKBUSTER ONLINE

After pulling the plug on its disastrous Film Caddy service, the gargantuan video chain returns with a slick interface and selection on par with Netflix. The recently launched Blockbuster Online looks promising, but we encountered long waits for popular films that smaller services had on hand. **\$20 per month for three discs at a time,** www.blockbuster.com



↑ WIRED

Giant library of current hits and classics. Free two-week trial. Subscribers get two complimentary in-store rentals per month.

↓ TIRED

Confusing search engine. No trailers.



◀ CAFEDVD.COM

Looking for the restored version of Orson Welles' *The Stranger* or Bob Marley's *Heartland Reggae*? Cult, foreign, art house, noir – Café DVD has 'em all. There's little chance you can out-observe them, and if you do, your suggestions stand a good chance of being added. Plus, turnaround is comparable to Netflix. **\$20 per month for three discs at a time,** www.cafedvd.com



↑ WIRED

Protective packaging prevents damaged discs. Per-rental pricing option starts at \$3 (plus shipping).

↓ TIRED

Unintuitive search. No trailers. Short on critically panned flicks.



◀ NETFLIX

Since its 1999 launch, this service has spawned droves of copycats. But with the largest number of distribution centers and a stock of 25,000 titles, Netflix is still tops. Its library is brimming with blockbusters, as well as indies and cult TV shows. Meanwhile, the site is loaded with features like reviews and Amazon.com-style personalized recommendations. **\$20 per month for three discs at a time,** www.netflix.com



↑ WIRED

Lickety-split next-day delivery for most customers. Fluid interface. Up-to-date film database lets users queue up titles not yet released to DVD. Movie trailers.

↓ TIRED

Prices keep creeping upward. The occasional scratched disc.



◀ WAL-MART DVD RENTALS

Wally World pulled together a library of 15,000 titles and began offering online rentals last year. Unfortunately, the service is buried deep within the retail behemoth's main Web site, which uses a puzzling search engine. The result? Film fans looking for their fave flicks often find themselves lost in a labyrinth of electronics and baby gear instead. **\$18.76 per month for three discs at a time,** www.walmart.com/dvdrentals



↑ WIRED

With a large movie selection at a slightly lower-than-average price, it's not a bad value. Offers a one-month trial.

↓ TIRED

Frustrating interface. Three-day deliveries. Expect to wait even longer for popular movies.

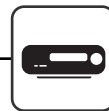

Movies-On-Demand

If the US Postal Service is too slow for your film habit, lug your laptop to the La-Z-Boy and get Hollywood hits piped in via broadband. – K.L.D.



◀◀ CINEMA NOW

The granddaddy of MOD offers a rotating library of 2,000 titles, plus download-to-own movies and cheesy adult flicks. Unfortunately chaos reigns: Pricing and viewing rules vary from film to film. The site's design is pretty clunky, but if your connection is fast enough, you can start watching the moment your download begins. **\$3-5 per viewing, \$30 per month, \$100 per year, www.cinemanow.com**



↑ WIRED

Porn! Huge catalog. Wish lists, trailers, and the option to subscribe instead of paying per movie.

↓ TIRED

Convolutd pricing. Cumbersome search engine. Library teems with lame titles.



◀◀ MOVIELINK

This two-year-old spawn of a Hollywood studio consortium offers a slim selection of about 900 films, though it has more new titles than any of its competitors. Simple pay-per-view pricing makes it clear how much each title will ping your pocketbook – but even \$5 stings when you're limited to one viewing. Plus, DRM software sucks the film from your hard drive 24 hours after you first hit Play. **\$2 to \$5 per viewing, www.movielink.com**



↑ WIRED

Easy software installation and site navigation. Works with both Real and Windows Media players. Offers bookmarks and a good selection of recent flicks.

↓ TIRED

A tad pricier than video stores and DVD delivery services.



◀◀ STARZ! TICKET ON REAL MOVIES

Here's a simple approach geared to casual viewers: Pay one low monthly fee for access to a basic catalog of movies. This new partnership of Starz! and RealNetworks resembles cable pay-per-view: About 150 films are available at a time, 25 percent of which change each week. The cost includes unlimited viewing of up to three registered PCs during a film's availability period. **\$13 per month, www.real.com/movies**



↑ WIRED

The ability to schedule downloads in advance. Bookmarks let you pick up where you left off.

↓ TIRED

Desperately Seeking Susan and the best of Vin Diesel not ideal choices for a library limited to just 150 titles.

QUICK TIP

Study fee structures. A subscription isn't worth it if the films you want to watch are pay-per-view only.



AUDIO

MP3 Players

The iPod rocks, but the competition is hotter than ever. There's more than one way to get your groove on. **by Brendan I. Koerner**



- 81 **20-Gig Hard Drive Players**
- 83 **Microdrive Players**
- 84 **Flash-Memory Players**

PLUS:

- 88 **Travel Speakers**
- 90 **Online Music Stores**

MP3 Player Essentials

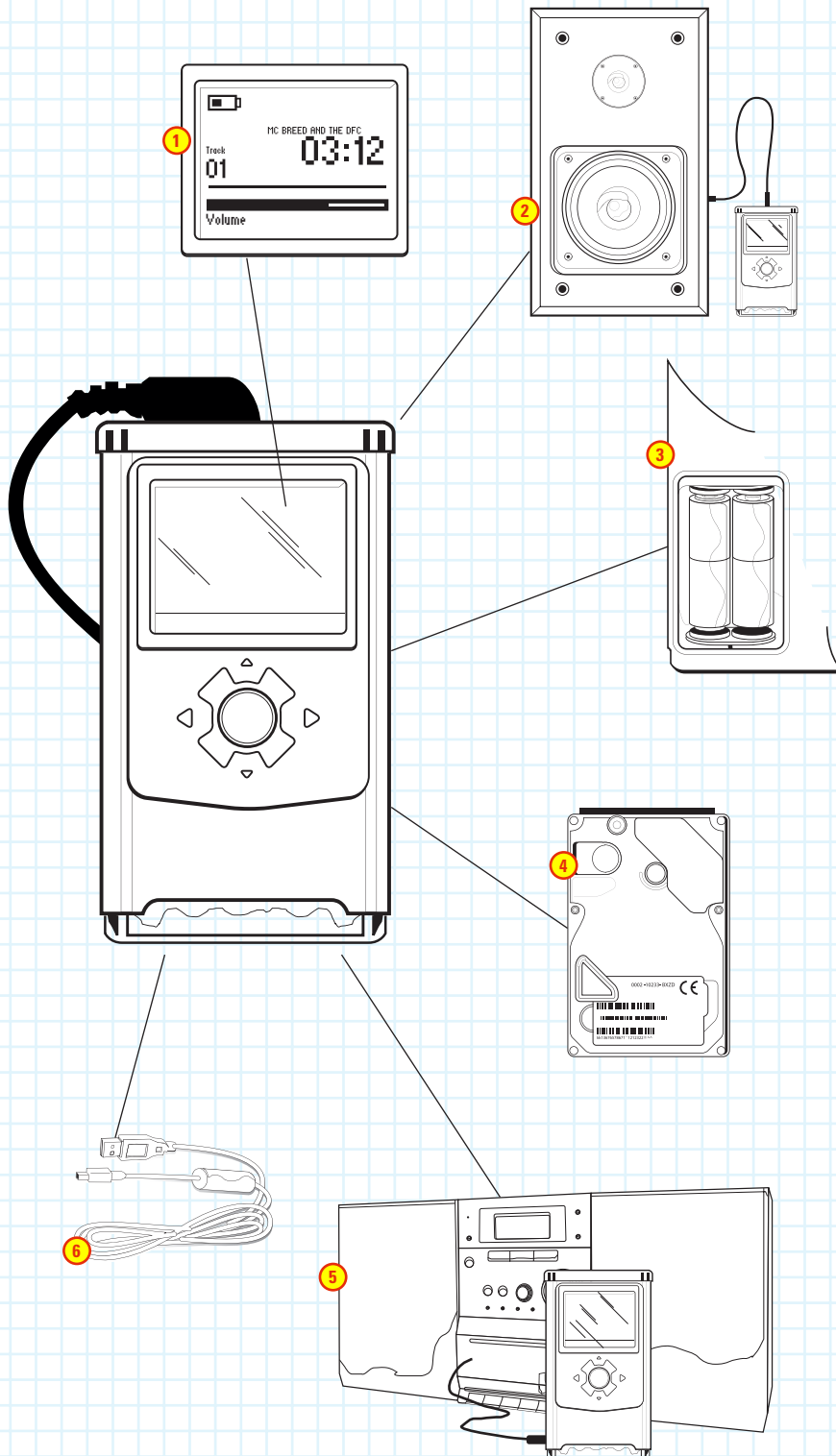

1 INTERFACE

Dialing up a song shouldn't be a finger-numbing chore. Beware of sticky buttons, confusing menus, and other design flaws. There's no rule as to what works best, so try before you buy.

2 SOUND QUALITY

Some players lose their composure at high volumes – frustrating especially if you're listening through speakers instead of headphones. Also, for fine-tuned playback look for preset or manual equalizer functions.

3 BATTERY LIFE

Flash-memory devices burn through less juice and take standard alkaline cells, while the power centers in hard drive players tend to degrade over time. Never trust manufacturer claims – the true lifespan is always lower.

4 STORAGE

If portability is the chief concern – say, for joggers or frequent travelers – a flash player is the way to go. Hard disk varieties cost and weigh more but are worth it if you want thousands of songs at your disposal.

5 LINE-IN RECORDING

Some units let you bypass your computer and dupe directly from a CD player or stereo.

6 FILE TRANSFER

Get a player with a USB 2.0 or Fire-Wire port. Life's too short to load up tunes at USB 1.1 speeds.



20-Gig Hard Drive Players

The iPod set a standard that once seemed unachievable: megastorage without megabulk. We cranked the volume on a half-dozen pocket jukeboxes.

EDITORS' PICK ✓



◀ APPLE IPOD

The **great-grandson** of the player that changed everything, the latest iPod adopts the mini's click wheel even as it sheds a few millimeters of girth. Best of all, this beauty costs a hair below \$300. Alas, it still lacks Windows Media Audio support, line-in recording, and an FM tuner. But Apple, we forgive you.

\$299, www.apple.com



↑ WIRED

An interface that is the measure of all others. Thin and light (5.6 ounces) for a hard disk player. Good sound. Healthy 25-minute skip protection. Oodles of add-ons.

↓ TIRED

iTunes software occasionally crashes in Windows.



◀ ARCHOS GMINI 220

The **Gmini 220** nearly knocks the pulp out of Apple's player. Its audio is every bit as good, and unlike the 'Pod, it plays WMA tracks. The large screen and menu icons make navigation a cinch; it even displays JPEGs. The main thing that kept the Gmini out of our top spot was the dearth of accessories available for it.

\$349, www.archos.com



↑ WIRED

Beautiful LCD. Type I/II Compact-Flash slot. Built-in microphone. USB 2.0. Smartly designed controls. Smooth transitions when moving through menus. Rich sound.

↓ TIRED

Fewer accessories than for the iPod. Slightly bigger than it, too.



◀ CREATIVE ZEN TOUCH

It **looks a lot** like the iPod, but in place of the click wheel the Zen Touch features a pressure-sensitive strip. Though a tad overresponsive, it works well once you get a feel for it. Also praiseworthy are the fast transfer rate and long battery life. Downers include heft (7 ounces) and sound quality, which lacks depth.

\$250, us.creative.com



↑ WIRED

Innovative (if hair-trigger) controls. Blazing transfers from PC to player. Stellar battery life – very close to Creative's claim of 24 hours. Fair price.

↓ TIRED

Not Mac compatible. Manual equalizer has only four bands. So-so sound. No built-in FM tuner.



◀ RIO KARMA

Though **chunky**, the Karma is a strong contender for hard disk domination. The control stick is a snap to master, and the onscreen menus are intuitively laid out – even playlist creation is easy. Songs are a bit slow to load, but features like line-in recording through the unit's dock make up for it. Bonus points for the ergo design.

\$300, www.rioaudio.com



↑ WIRED

Simple controls and menus. Plays MP3, WMA, WAV, FLAC, and Ogg Vorbis. Ethernet docking station lets you share tunes over a network.

↓ TIRED

PC-only. A little thick through the middle. Lags occasionally when fast-forwarding. No voice recorder or FM tuner.



◀ SONY NW-HD1

Sony's new hard drive player sounds good, looks great, and delivers a category-killing 29 hours of use on a single charge. Otherwise, it blows. The LCD is dim, the control pad cramped, and the menus arcane. The capper: The HD1 plays Sony's ATRAC3 and ATRAC3plus formats only. And the SonicStage software, included, takes too long to convert MP3s into ATRAC3s.

\$400, www.sonymstyle.com



↑ WIRED

Attractive design. Outstanding battery life. Rich audio.

↓ TIRED

Price is too much for too little. Hard-to-read screen. Tiny control pad. SonicStage feels like a giant ad for Sony's music store. Not Mac compatible.

SPLURGE



◀ TOSHIBA GIGABEAT G21

This import-only jewel is amazingly sleek. It's also Wi-Fi ready: Plug an 802.11 adapter into the USB port in the cradle and access your playlists over a wireless network. The LCD is just a thin strip, but its crispness compensates. Toshiba has yet to announce release plans for the US, but you can buy the Gigabeat online from Dynamism.

\$599, www.dynamism.com



↑ WIRED

Elegant design. Thin and light. Easy to operate. Wireless-ready. Plays MP3, WMA, and WAV files. Its 28 equalizer presets range from Acoustic to R&B.

↓ TIRED

Luxe price point. No built-in voice recorder or FM tuner. Controls are awkward. PC-only.

MP3 Players How We Tested



COMPUTER SETUP

Each piece of bundled file-management software was loaded onto a PC running Windows XP and, when appropriate, a Mac running OS X. For units that double as storage drives we also checked drag-and-drop transfers.



EQUALIZER

We tried out all the presets and tweaked manual EQs to gauge how well each enhanced the audio.



GENRES AND FORMATS

To see how players handled different music styles, we spun hip hop, rock, house, jazz, soul, country, and classical. In addition to MP3s, we downloaded WMA and Ogg Vorbis files.



PORTABILITY

We charged them up and hauled them around town to get a feel for how they perform in the outside world.

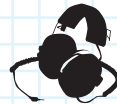

SOUND QUALITY

To judge output, we listened to each player with the bundled headphones and through a pair of Sony MDR-V300 studio cans. We also connected players to a Sony STR-5355 stereo with Sony APM-790 speakers to better determine the sonic range.



BATTERY LIFE

We ran the units nonstop until they conked out, and fiddled with a range of functions and controls (fast-forward, pause, volume) to mimic real conditions.



LINE-IN RECORDING

On devices that feature a line-in port, we recorded a track from a CD.



PLAYLISTS

We created at least one playlist on the computer and, if possible, on the player itself.



Microdrive Players

Larger than flash-memory devices but more portable than their storage-rich older siblings, these pack in enough music for long workdays or short trips.



◀ APPLE IPOD MINI

Sure, the mini looks like a zillion bucks, and the click wheel is nifty. But for 4 gigs the price is way too steep. And the sound isn't quite on par with its predecessor – especially when the volume is up high. Another knock: the unit's unimpressive battery life, less than six hours in our tests. Still, we're suckers for a hot bod.

\$249, www.apple.com



↑ WIRED

The design belle of the ball. Brilliantly crafted click wheel. Superfast FireWire transfers. Very bright backlight. 25-minute skip buffer.

↓ TIRED

Not much storage for the money. Doesn't play WMA files. Lackluster battery life. No voice or line-in recording. Lacks FM tuner.



◀ RIO CARBON

The new leader in microdrives is thinner and lighter than the competition. It also sounds better – even through the bundled earbuds. The Carbon has a microphone for voice recording, and you can add songs directly to your playlist, without software, via USB 2.0. At 5 gigs, it offers more storage than Apple's mini for the same scratch. Southpaw gripe: The jog wheel is out of thumb's reach.

\$250, www.rioaudio.com



↑ WIRED

Thin and light. Drag-and-drop transfers. Easy EQ adjustment. Deep bass makes it perfect for hip hop or electronica. Battery life tops 18 hours. High-quality built-in mike. Plays WMAs in addition to MP3 and Audible files.

↓ TIRED

Tough on lefties. No FM tuner.



◀ SONIQCAST ELEMENT AIREO

Much respect to the Aireo for cutting the cables: It scans your PC's hard drive and downloads audio files over your 802.11b network. The wireless transfers worked fine but rarely eclipsed USB 1.1 rates. Great idea, but the Aireo is heavy at 8 ounces and memory-poor at 1.5 gigs.

\$180, www.soniqcast.com



↑ WIRED

Syncs wirelessly with your PC's music library. Installation software is stored on player, so no discs to lose. Fast toggling between screens.

↓ TIRED

Big and heavy. Minimal storage. Works only with Windows XP and 2000 (with Service Pack 4). No USB 2.0 transfers. Feeble power.

QUICK TIP

Don't pay for extra storage if size matters most. What rocks on the road might suck at the gym.



Flash-Memory Players

Your iPod is great for commuting but feels like a brick at the track or on the treadmill. Grab a featherlight flash device for maximum mobility.



◀◀ BENQ JOYBEE 102R

Barely larger than a hand buzzer, the Joybee was the smallest and lightest tune carrier we encountered. It has no features to speak of, not even an LCD. This player is all about portability, and it delivers. It also sounds great, even hooked up to a stereo. The battery lasts only seven hours on a single charge, but it's easy to replenish via USB.

\$99, www.benq.com



↑ WIRED

Weighs half an ounce. Works with Windows, Mac, and Linux. Battery recharges through USB 2.0. Fast transfers with QMusic software.

↓ TIRED

No screen or EQ. Earbuds have annoying plastic bar between wires. Only 128 megs (a 256-Mbyte version is on the way).



◀◀ IRIVER iFP-890

iRiver's li'l guy is an all-around performer, weighing just 2.2 ounces – with battery – and packing a mighty-sharp LCD. A superb line-in recorder, the iFP-890 also packs a mike that captures speech with impressive clarity when the subject is within 10 feet. The stubby joystick works surprisingly well, and a single AA cell yields up to 32 hours of play time.

\$150, www.iriveramerica.com



↑ WIRED

Lightweight and comfortable to hold. Doubles as a file caddy. Great line-in and FM recording. Powerful amp. Plays open source Ogg Vorbis, plus MP3, WMA, and ASF files.

↓ TIRED

Music Manager software essentially a more complicated Windows Explorer. Bundled earbuds wouldn't stay in place.



◀◀ JENS OF SWEDEN MP-130

This Scandinavian expat has a gorgeous two-color screen that materializes, ghostlike, on the silver casing once the unit powers up. Aesthetics aside, the MP-130 had the best sound and clearest voice recording of any flash player we looked at. If only we'd paid more attention to the Swedish Chef on *The Muppet Show*, maybe we could decipher the Svenske user's manual.

\$180, www.jensofsweden.com



↑ WIRED

Unique, beautiful screen. Light (1.5 ounces with battery). Fast seek time. No software required. Great built-in mike. Quick USB recharge. Mac and Linux compatible.

↓ TIRED

USB 1.1 (at least tolerable in a 256-Mbyte player). Equalizer presets didn't do much for the audio. Memory not expandable.

Gadget abusers, take note: Flash devices are superdurable – and they're impervious to skips.



◀ NIKIE PHILIPS MP3RUN

Joggers will get an endorphin rush from the MP3Run. It includes a Bluetooth-enabled pedometer that clips onto shoelaces and feeds speed-and-distance info to the rubber-coated player. A digital voice announces your stats through the headphones at regular intervals. If you're not a dedicated runner, though, look elsewhere – sound and navigation aren't great. **\$299, www.nike-philips.com**



↑ WIRED

Music player and pedometer in one. Rugged. Battery recharges in an hour. Cool strobe light for visibility at night.

↓ TIRED

USB 1.1. Equalizer not manually adjustable. Sticky keys. Low 10-hour battery life. Wimpy output levels.



◀ RIO FORGE 256MB SPORT

Rio wins again, nabbing the checkered flag in our flash category to go with a first-place microdrive finish. The Forge features a crisp LCD, simple controls, and solid sound. Built for athletic use, it has an onboard stopwatch. But the real treat here is the expansion slot, which accepts SD and MMC cards. **\$170, www.rioaudio.com**



↑ WIRED

Upgradable memory. Ergonomic shape and controls. Nice 18-hour battery life. Stopwatch records and averages lap times. FM tuner and recorder. Comfortable earbuds.

↓ TIRED

No voice recording. Rio Music Manager is a pain to use.

MP3 Players Scorecard

	Rating	Model	Price	Capacity	Weight (ounces)	Battery Life (hours)	File Formats	Additional Features
20-GIG HARD DRIVE	4.5	✓ Apple iPod	\$299	20 Gbytes	5.6	9	MP3, AAC, WAV, AIFF, Apple Lossless, Audible	Many third-party accessories available
	4	Archos Gmini 220	\$349	20 Gbytes	6	7	MP3, WMA, WAV	Voice and line-in recording, manual EQ, card slot
	3.5	Rio Karma	\$300	20 Gbytes	5.5	12	MP3, WMA, WAV, Ogg Vorbis, FLAC	Docking station, line-in recording, manual EQ, instant syncing
	3.5	Toshiba Gigabeat G21	\$599	20 Gbytes	4.8	9	MP3, WMA, WAV	Wi-Fi ready
	3	Creative Zen Touch	\$250	20 Gbytes	7.1	19	MP3, WMA, WAV	FM tuner, FM and voice recording via optional remote, manual EQ
1	Sony NW-HD1	\$400	20 Gbytes	3.9	29	ATRAC3, ATRAC3plus	Manual EQ	
MICRODRIVE	5	✓ Rio Carbon	\$250	5 Gbytes	3.2	18	MP3, WMA, Audible	Voice recording, manual EQ
	3.5	Apple iPod mini	\$249	4 Gbytes	3.6	6	MP3, AAC, WAV, AIFF, Apple Lossless, Audible	Five color choices
	2	SoniqCast Element Aireo	\$180	1.5 Gbytes	8	5	MP3, WMA	FM tuner, Wi-Fi enabled, manual EQ
FLASH-MEMORY	4.5	✓ Rio Forge 256MB Sport	\$170	256 Mbytes	2.6	18	MP3, WMA, Audible	Stopwatch, FM tuner and recording, card slot, manual EQ
	4	BenQ Joybee 102R	\$99	128 Mbytes	0.5	7	MP3, WMA, WAV	Supersmall
	4	iRiver iFP-890	\$150	256 Mbytes	2.2	32	MP3, WMA, Ogg Vorbis, ASF	FM tuner, voice and line-in recording, manual EQ
	3.5	Jens of Sweden MP-130	\$180	128 Mbytes	1.5	15	MP3, WMA, Ogg Vorbis	FM tuner, voice and line-in recording, manual EQ
	3	Nike Philips MP3Run	\$299	256 Mbytes	2.5	10	MP3, WMA	Pedometer, strobe safety light



Portable Speakers

Headphones are fine when you're on a plane, but you'll want one of these baby blasters when you're baking on the beach or hanging at the hotel. — Cathy Lu

ALTEC LANSING INMOTION iM3

Slip your iPod into the inMotion's slot, and you've got an elegant boom box that also functions as a dock for syncing and recharging. It delivers warm, rich sound and features a remote control and an auxiliary port for connecting other audio devices.

\$180, www.alteclansing.com



CREATIVE TRAVELSOUND i300

The TravelSound i300 puts smooth, clean sound in a damn cute package. It's perfect for the office — plug in headphones and the speakers mute automatically. But all the jacks are in the back, so the cables tend to get tangled.

\$80, www.creative.com



SONY SRS-T88

This portable kit is handsome, light, and compact. And it comes with a convenient case and a world voltage adapter. The attached audio cable wraps neatly around the unit, making it easy to store and hard to lose. Sadly, the cable is too short, and the sound is hollow and tinny.

\$90, www.sonystyle.com



JBL ON TOUR SHOWN

Imagine Luciano Pavarotti's voice coming out of Brad Pitt's body. That's the JBL On Tour. A curved door protects the speakers while you're in transit and slides open to serve as a stand when you're ready to rock. Its aluminum-domed drivers, powered by a 6-watt digital amp, handled everything from Beck to Bach with gusto.

\$100, www.jbl.com

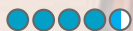

Online Music Stores

They're fast, cheap, and tightly controlled. But with massive libraries and consistent quality, online music stores rival the P2P networks that inspired them. – Paul Boutin

ALL FMP3

◀ ALL OF MP3

Invoking the authority of "license # LS-3?-03-79 of the Russian Multimedia and Internet Society," this site, allegedly based in Moscow, sells downloads at about a penny a megabyte. It offers nearly every format in a range of bitrates – all free of copy protection. You pony up using CyberPlat, a sort of Russian PayPal, so there's no credit card info on file.

About 6 cents per song, www.allofmp3.com



↑ WIRED

Cheap! Easy to use. Offers albums not available from US services.

↓ TIRED

Artists almost surely get nothing. No file-management software.



◀ APPLE iTUNES

Apple fans would plug into iTunes whether it deserved it or not. But the store earns its 70 percent market share with innovative features, a stylish interface, and rock-solid stability on both PCs and Macs. And, of course, it's not just a first-class record shop – it's also a music management tool. The catch? iTunes works only with iPods, which start at a budget-busting \$249 (for a measly 4 gigs).

99 cents per song, www.itunes.com



↑ WIRED

Tight integration with iPods. Extras include Billboard charts, free streaming of Internet radio stations, audio books, exclusive tracks, and celebrity playlists.

↓ TIRED

No monthly subscription option.

◀ MSN MUSIC

Microsoft is late to the party, and – surprise – has used the time to mimic what everyone else is doing. The download page features Mac-esque lozenge buttons, and like iTunes, MSN charges 99 cents per song and allows files to reside on five devices at once. But Microsoft can't match Apple when it comes to usability. The Web interface confuses with an inconsistent design and too many subwindows.

99 cents per song, music.msn.com



↑ WIRED

Its 160-Kbps WMAs sound better than iTunes' 128-Kbps AAC files.

↓ TIRED

Runs only on Internet Explorer. No Mac support. Cluttered interface.



◀ NAPSTER 2.0

The reborn Napster has little in common with the file-swapping software that started it all. Instead, Napster 2.0 offers dual service plans that combine the best traits of iTunes and Rhapsody. Pay the monthly rate and you can preview songs in their entirety before buying them.

\$9.95 per month or 99 cents per song, www.napster.com



↑ WIRED

Desktop software's interface shamelessly (and successfully) apes iTunes' great design. Similar selection as iTunes, plus Napster-only exclusive tracks.

↓ TIRED

Some songs can only be streamed, not downloaded.





◀ Rhapsody

If you use your PC like a jukebox, and you have a broadband connection, Rhapsody offers a tempting deal: stream as many songs as you want, as often as you want, for just 10 bucks a month. For offline listening, you can burn custom CDs from most of the service's library and then rip the disc's songs to your hard drive.

\$9.95 per month, plus 79 cents per song burned to CD, www.rhapsody.com



↑ WIRED

Fewer dropouts than other Internet radio providers. You can burn music to CD as you listen.

↓ TIRED

Some songs not available for burning. Can't download directly to hard drives or portables. Windows only.



◀ SONY CONNECT

Sony's attempt to move in on Apple's turf is hampered by a bloated (35-Mbyte!) desktop app with a gaudy, meandering interface that seems designed by, or perhaps for, space aliens. And unlike iTunes, Connect is a lousy tool for organizing your digital library. Its only saving grace is that it's intended for use with Sony portables, which start at less than half the price of an iPod mini.

99 cents per song, www.connect.com



↑ WIRED

Selection similar to iTunes, but also offers some exclusive tracks. Works with Sony's low-cost players.

↓ TIRED

No Internet radio stations. Proprietary ATRAC3 file format won't work with non-Sony players.



◀ WAL-MART MUSIC DOWNLOADS

Wal-Mart brings its cheaper-than-the-rest ethos to downloads and dispenses with software installation by using the Windows Media Player built into most PCs. Sure, it undercuts the competition by 11 cents per song, but it censors any lyrics it deems too racy. For example, the Bloodhound Gang's "Hooray for Boobies" becomes the nearly vocal-free "Hooray."

88 cents per song, www.musicdownloads.walmart.com



↑ WIRED

No software to install. Low per-song fees. "Chill Out" playlist should be mandatory listening for aspiring hipsters.

↓ TIRED

Limited selection. Windows-only copy protection means Mac users are not welcome.

Online Music Stores Scorecard

Rating	Service	Price	Songs in Library	File Formats	System Requirements	Maximum Computers per Download	Software Required
4.5	Apple iTunes	99 cents per song	1 million	AAC	Mac OS 10.1.5; Windows XP, 2000	5	Yes
4	AllofMP3	About 6 cents per song	280,000	MP3, AAC, WMA, Ogg Vorbis, MPC, and more!	Just about anything	Unlimited	No
4	Napster 2.0	\$9.95 per month or 99 cents per song	700,000	WMA	Windows XP, 2000	3	Yes
3.5	Rhapsody	\$9.95 per month, plus 79 cents per song burned to CD	780,000	WMA, Red Book Audio	Windows XP, 2000, Me, 98SE, NT; Internet Explorer 5.0	Unlimited	Yes
3	MSN Music	99 cents per song	1 million	WMA	Windows XP, 2000, 98SE; IE 5.01 with ActiveX	5	Yes
2	Wal-Mart Music Downloads	88 cents per song	300,000	WMA	Windows XP, 2000, Me, 98SE; Media Player 9.0; IE 5.5	3	No
1	Sony Connect	99 cents per song	700,000	ATRAC3	Windows XP, 2000, Me, 98SE	3	Yes



AUDIO

Home Theater Gear

Just dropped a bundle on a plasma? You're getting only half the experience. Add room-shaking sound for the complete blockbuster thrill ride.

- 95 **6.1 Surround Systems**
- 97 **Autocalibrating Receivers**
- 98 **12-Inch Subwoofers**
- 99 **Virtual Surround Systems**

PLUS:
101 **High-End Clock Radios**



Home Theater Gear Essentials

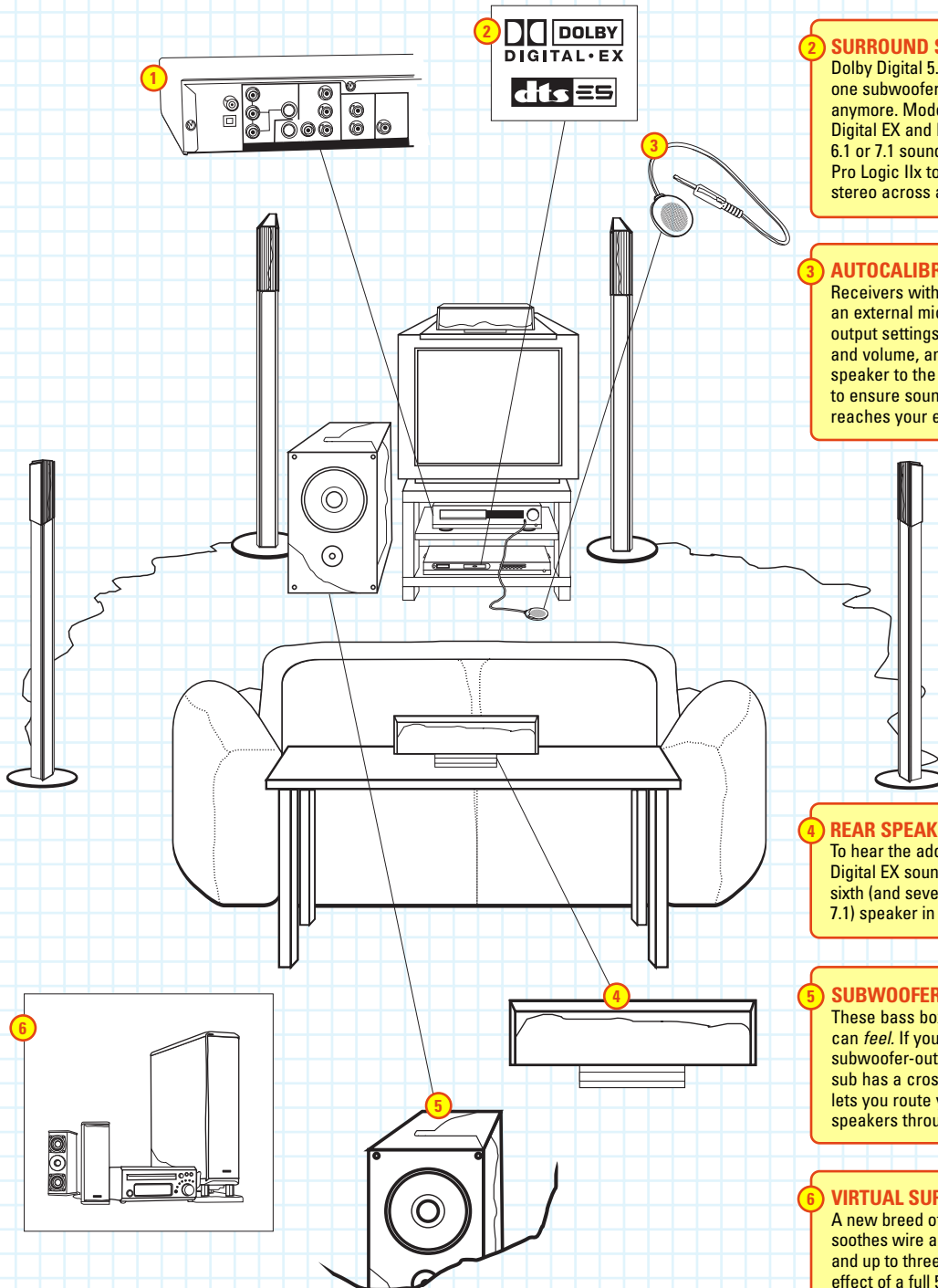

1 RECEIVER INPUTS

You'll want a receiver with a slew of inputs. In particular, look for six-channel RCA inputs for DVD-Audio, optical and coaxial jacks for digital audio, and component video inputs for HDTV.

2 SURROUND SOUND FORMATS

Dolby Digital 5.1 (five speakers plus one subwoofer) isn't the standard anymore. Modern amps decode Dolby Digital EX and DTS ES for authentic 6.1 or 7.1 sound and can use Dolby Pro Logic IIx to spread two-channel stereo across a 7.1 array.

3 AUTOCALIBRATION

Receivers with autocalibration use an external microphone to optimize output settings such as speaker size and volume, and distance from the speaker to the listener – important to ensure sound from each channel reaches your ears at the same time.

4 REAR SPEAKERS

To hear the added depth of Dolby Digital EX soundtracks, place your sixth (and seventh if your system is 7.1) speaker in the back of the room.

5 SUBWOOFER

These bass boxes add low end you can *feel*. If your amp doesn't have a subwoofer-out channel, be sure your sub has a crossover function. This lets you route your main left and right speakers through your subwoofer.

6 VIRTUAL SURROUND

A new breed of home theater kits soothes wire angst by using software and up to three speakers to mimic the effect of a full 5.1 system.



6.1 Surround Systems

The best home-theater-in-a-box kits now offer a sixth channel, letting you hear explosions, dialog, or music from directly behind you. – Michael Gowan

EDITORS' PICK



Denon DHT-485DV

Denon's system comes close to achieving affordable perfection. Textured scenes, like the opening of *The Fellowship of the Ring*, resonate with warmth and depth. The front speakers are a bit wimpy at stereo music, but the listening improves if you engage the sub and surround speakers via the Pro Logic IIx Music setting.

\$699, www.usa.denon.com



↑ WIRED

DVD player reveals details lost by other models. Lots of analog inputs, including ones for DVD-Audio.

↓ TIRED

Only two digital audio inputs. Front speakers a little thin for music.



JVC QP-F30AL

This feature-rich package comes with some nice perks, including stands for front and surround speakers and a clever auto-adjust feature. Sit in your favorite spot, clap your hands over your head, and the amp balances volume levels for you. But techie extras don't help overall sound, which suffers from murky bass, limp vocals, and raspy treble.

\$1,200, www.jvc.com



↑ WIRED

Plays DVD-Audio discs. Elegant speaker stands look great next to a plasma screen.

↓ TIRED

Lackluster sound – a classic case of style over substance. Overly complicated remote.



Kenwood HTB-S715DV

When it came to doling out movie audio, this rig outperformed every competitor we threw at it. Kenwood's system captures immersive back-and-side-channel subtleties completely missing in other setups. Unfortunately, despite a thumpin' subwoofer, voices lack bass and stereo audio sounds hollow.

\$1,000, www.kenwoodusa.com



↑ WIRED

Easy front-panel inputs for game consoles. Gorgeous brushed-metal components and speakers drip with modernity.

↓ TIRED

No optical output (coaxial only) or DVD-Audio support.

QUICK TIP

Take the time to fine-tune your system's settings – it'll make a huge difference in sound quality.

AUDIO HOME THEATER GEAR



◀ ONKYO HT-S777C

Despite its wooden appearance, Onkyo's kit pumped out the jams with serious bass and warm treble. While the spatial separation didn't match the systems we tested from Yamaha and Kenwood, rich CD playback made the Onkyo HT-S777C our pick for music lovers. The amp is lousy with inputs, including three optical, four analog, and two component video sets.

\$700, www.onkyo.com



↑ WIRED

Full, rich sound. Crisp video playback from the six-disc DVD changer. Abundant rear-panel connection options.

↓ TIRED

Won't win a beauty pageant. Crammed-together speaker jacks hard to access and tighten properly.



◀ YAMAHA YHT-F1500

With its silver components and tall, slim speakers, Yamaha's offering looks straight-up high-end home cinema. And it produced exceptional surround effects: You'll think bullet casings are dropping at your feet during *The Matrix*. But the system lacks distinctive bass – we noticed it especially when listening to CDs – and video output falters during dark scenes.

\$1,000, www.yamaha.com



↑ WIRED

Well-distributed sound puts you in the picture. Elegant on-screen display makes setup easy.

↓ TIRED

Muddy bass and tinny treble equal unbalanced audio. No component video, so no HDTV support.

Home Theater Gear How We Tested

6.1 SURROUND



MOVIE PLAYBACK

To assess audio and video quality, we watched *The Matrix* in Dolby Digital, and *Star Wars: Episode I – The Phantom Menace* and *The Fellowship of the Ring* in Dolby Digital EX.



MUSIC PLAYBACK

We played tracks by Wynton Marsalis and Mozart in stereo and Dolby Pro Logic IIx Music modes, and the Flaming Lips in Dolby Digital.

12-INCH SUBWOOFERS



RUMBLE AND NUANCE

Each sub was placed in the same location in the room and set to the same volume level using a decibel reader. We then judged low-end output in *Jurassic Park*, *The Fellowship of the Ring*, *Fight Club*, and the DTS Superbit version of *Das Boot*. We listened for subtle bass overtones, the ability to stay true at loud volumes, and sheer rumble.

AUTOCALIBRATING RECEIVERS



SPEAKER OPTIMIZATION

Autocalibration amps set themselves to a Denon DVD player, Dynaudio Contour speakers, and a REL Storm III subwoofer. We then judged output with the DVDs *The Matrix*, *The Thin Red Line*, and *Kill Bill: Vol. 1*; the Super-Audio CD *Sea Change*, by Beck; and DVD-Audio discs *Legions of Boom*, by Crystal Method, and *Uninvisible*, by Medeski, Martin & Wood.

VIRTUAL SURROUND



EMULATION AND PERFORMANCE

We calibrated each system to matching volume levels and left all other settings at default. We then played a series of music-, dialog-, and action-heavy scenes from *The Matrix Revolutions*, noting tone quality, spatial effects, dialog clarity, and clarity and steadiness at high volume.



Autocalibrating Receivers

In addition to processing audio and video, these amps use a microphone to adjust themselves for optimal sound quality. – **Steve Guttenberg**



◀ DENON AVR 3805

The 7.1-channel 3805 effortlessly autocalibrates, assessing speaker size and distance to the listener, then balancing output accordingly. Its 120 watts per channel are in full evidence on special effects-driven DVDs, coasting through the most demanding sonic mayhem. And the big, warm sound flatters music equally well.

\$1,199, www.usa.denon.com



↑ WIRED

Super Audio, DVD-Audio, and even phono inputs (a rarity on modern amps). Customizable speaker settings aplenty.

↓ TIRED

Remote's deep-blue membrane screen looks hip, but its morphing display will irk some users. Auto-calibration mike not included.

◀ HARMAN KARDON AVR 330

With satellite and subwoofer tuning options that can accommodate a wide range of speaker combos, the 330 can adapt to almost any situation. The automatic calibration uses a microphone cleverly built into the remote control. But where the Denon model tends to warm up sound, this amp's output is exceedingly neutral.

\$799, www.harmankardon.com



↑ WIRED

Its 55 watts per channel are at least as potent as most 100-watt competitors. Front-panel bass and treble controls are a welcome blast from the past.

↓ TIRED

Autocalibration balances speaker levels only – other settings must be adjusted manually.

◀ PIONEER VSX-D914-K

This Pioneer receiver offers quality sound for much less cash than the other units we tested. Music is clear and clean, though vocals, guitars, and brass instruments lack their natural warmth. The amp tends to clip at high volumes, causing the audio to coarsen, but at moderate levels the sound stays true.

\$475, www.pioneerelectronics.com



CHEAP THRILL



↑ WIRED

Lots of power for not a lot of cash. Autocalibration mike included.

↓ TIRED

No TV-screen menus means muddling through cryptic messages on the small display. Limited input options compared to other receivers.

QUICK TIP

For best results, make sure the room is as quiet as possible when calibrating your receiver.

12-Inch Subwoofers

Pump some bass in your place. A quality subwoofer blows serious low-end into action flicks and music picks. – **Robert Capps**



◀ HSU SFT-3

The **HSU monster** packs plenty of punch and holds its mud at high levels. We found ourselves cowering from mines dropped in *Das Boot* and recoiling from blows delivered in *The Fellowship of the Ring*. Though the SVS maintains the edge in performance, this sub is perfect for those who think it's hipper to be square.

\$599, www.hsuresearch.com



↑ WIRED

Big size delivers big impact. Sound held up at serious volumes. Short, so it can hide behind furniture.

↓ TIRED

Slightly less shake than the SVS (at the same volume).



◀ JBL E250P

The **E250P has less power** than the other subs we tested (250 watts to their 300-plus), so we weren't surprised when it didn't produce as much tangible rumble. But it costs about \$100 less, and it lends respectable bottom to beats and bombs alike. For small-to-medium setups, this is a solid choice.

\$499, www.jbl.com



↑ WIRED

Good value. Withstood nearly all 250 watts of its amplifier. Small, so it won't dominate decor.

↓ TIRED

No built-in crossover – if your receiver doesn't have a subwoofer-out, steer clear.



◀ SVS 20-39 PCi

SVS puts a round peg in a square hole. Its 3-foot-tall, 16-inch-wide tube-shaped sub slims its footprint by going high instead of wide. The PCi proved smooth and subtle as well as strong, giving the Dust Brothers' opening track to *Fight Club* plenty of palpable presence and turning *Jurassic Park's* T-rex steps into terrifying thuds.

\$599, www.svsubwoofers.com



↑ WIRED

Smooth, deep bass, even when cranked. Lots of palpable vibration in addition to audible sound. Only model with composite output for linking multiple subs.

↓ TIRED

Cats may mistake it for a giant scratching post.



An Earthquake in Your Living Room

Follow these tips to go seismic with your subwoofer.

PLACE IT IN THE CORNER You'll get more bass response if the sub can roll its thunder off walls, not just the floor.

TURN IT UP Because they deal in frequencies at the threshold of human hearing, subs can be hard to distinguish. Set yours a bit louder than the other speakers so you know it's there.

DOUBLE DOWN Two subwoofers can be better than one, with deeper bass response at a lower overall volume, so you don't have to crank it to 11 and irritate the neighbors. Plus, any speaker sounds better when it's operating below maximum output. So if you get a solo sub home and find it's not enough, just add another with a Y adapter or composite splitter. – **R.C.**



Virtual Surround Systems

Want a wilderness of sound without the forest of speakers? These systems promise engulfing audio without requiring you to wire the living room. – **Chris Anderson**



◀ BOSE 3-2-1 GS SERIES II

The new version of Bose's category-launching system delivers big sound through surprisingly small speakers. The main changes are subtle – better software and a progressive-scan DVD player. Overall it's pretty much what you'd expect from Bose: solid sound at a premium price.

\$1,299, www.bose.com



↑ WIRED

Visually unobtrusive. Good balance of spatial-effect simulation and overall sound quality.

↓ TIRED

Slightly shrill due to weak midrange. Few input and output options. Expensive.



◀ DENON D-M51DVS

Denon's two-channel system radiates quality. The rosewood subwoofer perfectly matches the out-board speakers. The combination DVD player and amp is tiny, solid, and surprisingly powerful. Best of all, it sounds fantastic, filling even a medium-size room with rich, full-spectrum audio. Just don't expect stunning spatial effects.

\$800, www.usa.denon.com



↑ WIRED

Classy wood finish. Big, full-bodied sound. Easy to set up.

↓ TIRED

Very little surround effect. Dialog blurred by ambient sound.



◀ KEF INSTANT THEATRE

Twin cast-aluminum cabinets combine forward-firing cone drivers with flat-panel speakers that project audio sideways. It all felt weighty and solid – until we plugged everything in and noted the minimal spatial effects, unimpressive power, and narrow tonal range.

\$1,500, www.kefinstanttheatre.com



↑ WIRED

Solid construction. Aggressively high-tech design.

↓ TIRED

Strains to fill a medium-size room. Minimal surround effects. Pricy.

QUICK TIP

Where you sit can make or break the spatial effects. Front and center is the place to be.



◀◀ **NIRO REFERENCE SYSTEM**

With a single horizontal speaker box housing five individual drivers, plus the requisite subwoofer, Niro's Reference achieves much of what you'd expect from a full 5.1 setup: a distinct center channel for dialog, ambient sound from the sides, and some impressive zoom-around-your-head effects.

\$900, www.niro1.com/en



↑ **WIRED**

Easiest installation of the units tested. The best virtual system at spatial realism. Clear center channel presence.

↓ **TIRED**

Weak subwoofer. Better for dialog and ambient sound than for explosions or thumping music.

Home Theater Gear Scorecard

AUDIO HOME THEATER GEAR

Category	Rating	Model	Price	Receiver Output	High-End Inputs	Additional Features
6.1 SURROUND SYSTEMS	4.5	✔ Denon DHT-485DV	\$699	Six 110-watt channels	optical, coaxial audio; 3 sets component video	Dolby Pro Logic IIx
	4	Onkyo HT-S777C	\$700	Six 130-watt channels	3 optical, coaxial audio; 2 sets component video	Six-disc changer, Dolby Pro Logic IIx
	3.5	Kenwood HTB-S715DV	\$1,000	Six 130-watt channels	3 optical, 2 coaxial audio; 2 sets component video	Dolby Pro Logic IIx, Dolby Headphone mode
	2	JVC QP-F30AL	\$1,200	Six 100-watt channels	optical audio; 2 sets component video	Autocalibration, proprietary 3-D headphone mode
	2	Yamaha YHT-F1500	\$1,000	Six 100-watt channels	2 optical, coaxial audio	Dolby Pro Logic IIx, compact components
AUTOCALIBRATING RECEIVERS	Rating	Model	Price	Receiver Output	High-End Inputs	Autocalibration Options
	5	✔ Denon AVR 3805	\$1,199	Seven 120-watt channels	5 optical, 2 coaxial audio; 3 sets component video	Speaker size, volume, and distance to listener
	4	Harman Kardon AVR 330	\$799	Seven 55-watt channels	3 optical, 3 coaxial audio; 2 sets component video	Speaker volume
3.5	Pioneer VSX-D914-K	\$475	Six 110-watt channels	3 optical, 2 coaxial audio; 2 sets component video	Speaker size, location, and distance to listener	
12-INCH SUBWOOFERS	Rating	Model	Price	Rated Power and Frequency Range	Dimensions (inches)	Additional Features
	4.5	✔ SVS 20-39 PCi	\$599	320 watts, 100 Hz-20 Hz	39 (height) x 16 (diameter)	RCA audio output for linking multiple subs, built-in crossover
	4	HSU SFT-3	\$599	300 watts, 1 KHz-25 Hz	22 x 15 x 23	Built-in crossover
3	JBL E250P	\$499	250 watts, 150 Hz-25 Hz	19.8 x 14.5 x 16.5	Small footprint	
VIRTUAL SURROUND SYSTEMS	Rating	Model	Price	Receiver Output	High-End Inputs	Additional Features
	4	✔ Denon D-M51DVS	\$800	Two 35-watt channels, 100-watt sub	2 optical audio	Hardwood cabinet, Dolby Headphone mode
	3.5	Bose 3-2-1 GS Series II	\$1,299	Information not available	optical, 3 coaxial audio; component video	Universal remote
	3	Niro Reference System	\$900	Two 30-watt channels, 50-watt sub	3 optical, coaxial audio	Card slot for future software upgrades
2.5	KEF Instant Theatre	\$1,500	Information not available	optical audio	Cast-aluminum frame	



High-End Clock Radios

Today's deluxe tabletop radios are unobtrusive in any bedroom, pumping out rich sound from a compact perch on your nightstand. — Lucas Graves

TIVOLI AUDIO MODEL THREE AM/FM CLOCK RADIO

SHOWN

This **amped-up** speaker box combines retro chic with warm, full sound. The midrange driver built into the cabinet lends bass notes a surprising amount of heft. For an extra \$50, add a second channel (on a 15-foot cord) for true stereo separation. The sound may be a shade less expansive than what Cambridge's bedside model produces, but Tivoli scores points for style and grace.

\$200, www.tivoliaudio.com



AUDIO
HIGH-END CLOCK RADIOS

CAMBRIDGE SOUNDWORKS RADIO 730

The **730's design** may have the sex appeal of a shoebox, but the sound it puts out will have you dancing in your PJs. Plus, it's ultra-programmable, with snooze options and alarms that can be set to different stations and volume levels.

\$200, www.cambridgesoundworks.com



BOSE WAVE MUSIC SYSTEM

Bose's **buttonless** cabinet looks superclean — all the controls are on the wafer-thin remote. Audio quality nearly matches that of the Cambridge. Too bad the price doesn't. Another bummer: Auto-equalization prevents manual adjustment of bass and treble.

\$499, www.bose.com



BOSTON ACOUSTICS RECEPTOR RADIO

The **least-expensive** clock radio we tested, Boston Acoustics' tabletop is also the best at locking in weak stations. The Receptor's clever interface reduces clutter and makes setting the alarms a snap. But it couldn't quite match the others for fidelity.

\$159, www.bostonacoustics.com





AUDIO

Headphones

The latest sound providers cushion you in comfort, mute a jet engine's roar, or put a cineplex between your ears. **by Paul Boutin**

- 105 **Hi-Fi Headphones**
- 106 **Surround Sound Headphones**
- 107 **In-Ear Headphones**
- 108 **Noise-Canceling Headphones**



Headphones Essentials

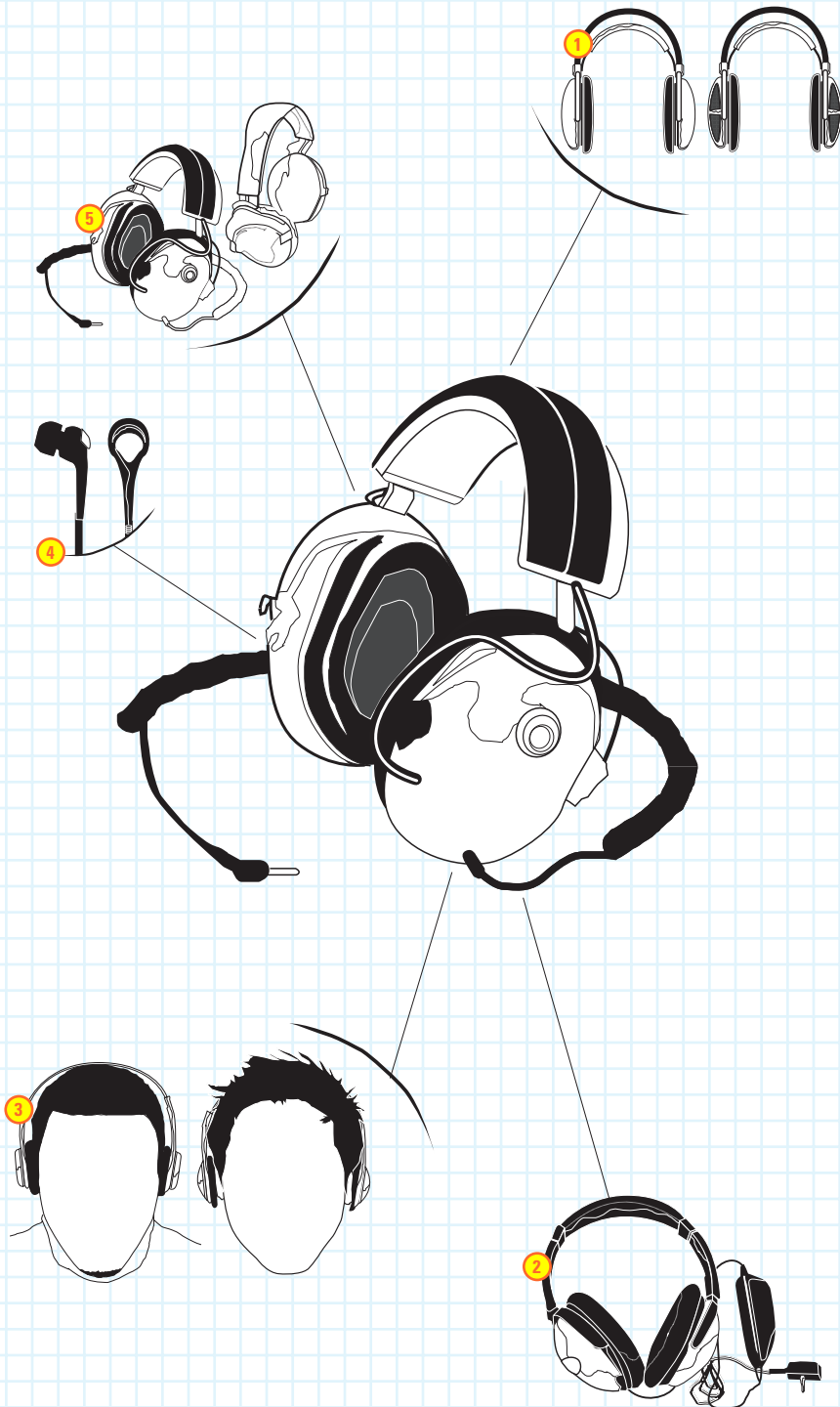

1 CLOSED OR OPEN

The earpieces of closed-back headphones seal you off from the outside world. A top-notch set is more isolating than noise-cancelers. The mesh backs of open earpieces let the speaker drivers resonate more freely, which can make for truer audio. But remember: Sound seeps both ways.

2 NOISE-CANCELING

These use an embedded microphone to detect sound waves, then pipe mirror-opposite frequencies into your ears to cancel out ambient clatter. The tech kills steady whines dead but only lowers uneven sounds, like the yakking of coworkers.

3 CIRCUMAURAL OR SUPRAURAL

The Latin says it all: A circumaural speaker engulfs the ear, creating a padded seal against the skull. A supraural speaker has a cushion that rests atop the outside of the ear. Most people love one and hate the other, but you'll never know which style you prefer until you try both.

4 IN-EAR

Unlike the buds included with most MP3 players, these tuck deep inside your ear canals to position the drivers as close to your eardrums as possible. The pluglike design helps dampen background noise.

5 WIRED OR WIRELESS

Cutting the cord lets you roam, but you'll pay in audio quality. Infrared headsets sound best, though the signal won't penetrate walls. Radio-frequency models suffer static but let you listen from the backyard.



Hi-Fi Headphones

The **armchair elite** pack advanced speaker technologies (piezoelectric films, neodymium magnets) into earpieces plush enough for long-haul listening.



◀ GRADO RS-1

The **chassis** on these audiophile classics are handcrafted from cured mahogany, making them both light and dynamic. Don't expect block-rockin' bass, but do marvel at the clarity of your Steely Dan records. And thanks to the fully open design, you can have a conversation without reaching for the volume knob.

\$695, www.gradolabs.com



↑ WIRED

Amazing sonic detail. Attractive wood styling. Leather headband, gold-plated jack, and 15-foot extension cord included.

↓ TIRED

Loose fit awkward for some. Bass fiends, look elsewhere.



◀ KOSS PRO3AA

This **circumaural set** from the 1970s has been updated with titanium-coated speakers and a metallic finish. The closed earpieces, surrounded by a snug padded seal, let us pump up the volume without driving housemates crazy (although they made us feel claustrophobic after a while). Bass was strong but occasionally boomy.

\$70, www.koss.com



↑ WIRED

A basement bargain in good sound. Flashy looks. Closed design keeps the peace at home.

↓ TIRED

Sound quality diminishes as you crank the volume. All-day listening wears on the ear.



◀ SENNHEISER HD 555

Designed for movies as well as music, these 'phones enclose even the biggest ears with snug cloth-covered padding that won't irritate your head during those Miles marathons. Reflective barriers in each bucket lend a spatial effect without decoding software or extra speaker channels.

\$170, www.sennheiser.com



↑ WIRED

Supercozy earpieces and headband. Clean, clear sound even at max volume. Wide spatial separation for home theater use.

↓ TIRED

The reflective barriers are built in, so you can't turn off the effect for flatter audio.



◀ STAX SIGNATURE SYSTEM II

They look like something from a 1940s mind-control experiment, but with audio this full you won't want to leave the lab. Stax matches electrostatic speakers for accuracy with a vacuum-tube headphone amp for warmth. These are the best-sounding cans we tried, but we had to ding them for the exorbitant price.

\$1,700, www.yamasinc.com



↑ WIRED

Full, detailed reproduction. Unbeatable for jazz, classical, or electronic music. And, of course, vacuum tubes rock.

↓ TIRED

Bass too shallow for B-boys and ravers. For the price, you can get season tickets to the symphony.

Surround Sound Headphones

How do you get 5.1 audio out of only two speakers? Some sets use advanced acoustical modeling. Others cram three full channels into each ear.



◀ PIONEER SE-DIR800C

For pseudo-surround on a relative budget, these cordless cans deliver. While they lack a directional stabilizer, they're also minimally gizmotronic – the base station is small and fits in with living room decor. We were disappointed, though, by the mediocre sound quality of the undersize drivers.

\$399, www.pioneerelectronics.com



↑ WIRED

Wireless operation with minimal knobs and buttons. Transmitter doubles as charger.

↓ TIRED

Wonky headset design. Pricy.



◀ SONY MDR-DS8000

Sony's wireless headset merges Dolby's virtual surround technology with a gyroscopic control to track where sound should come from. Turn your head to the right and the simulated field rotates to compensate. It made the surround experience seem much more real.

\$799, www.sonymstyle.com



↑ WIRED

Graphic display on transmitter unit shows surround channel placement. Two digital inputs.

↓ TIRED

Annoying hiss, audible at low volumes, mocks large price tag.



◀ ZALMAN ZM-RS6F

These 'phones spread sound from three full speakers – front, center, rear – built into each ear. There's no onboard processing (three stereo jacks connect to outputs on a PC or home theater receiver), so a good soundcard or A/V amp is essential.

\$70, www.zalmanusa.com



↑ WIRED

Inexpensive but solid choice. Great spatial effects. Perfect for PC gamers.

↓ TIRED

So-so bass. Lame PC soundcards even lamer in surround.

Headphones How We Tested

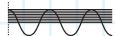

FIDELITY

All models (except surround sound) were evaluated using a 24-bit studio console and a vintage turntable plugged into a tube amp.



MUSIC STYLES

Our two-hour playlist merged stereo-store standards – Miles Davis, Michael Tilson Thomas, Pink Floyd – with a few guilty pleasures. We know what Rush should sound like.



NOISE REDUCTION

We plugged in-ear and noise-canceling headphones into an iPod and took them for a stroll around the city. We also listened on a crowded commuter flight.



SURROUND SOUND

For surround sound units we watched *The Matrix Revolutions* in Dolby Digital and played the EAX-encoded PC game *Far Cry*.



In-Ear Headphones

Crest Mount Fuji with the London Philharmonic in tow. These must-have upgrades for MP3 players merge big-bucket power and precision with earbud portability.



◀ APPLE IPOD IN-EAR HEADPHONES

Apple's canal 'phones are affordable, but you're not hearing all you could. They're comfortable, too, but only because they don't reach very far into the ear. High volumes sound decent, with expressive midrange, but you'll miss the rest of the mix.

\$39, www.apple.com



↑ WIRED

Good response in vocal range. iPod-matching white keeps it simple.

↓ TIRED

Not much warmth, definition, or bass. Fanatical iPod fans should be willing to pay more for a better bud.



◀ ETYMOTIC ER-4P

If you like to rock out, this is the in-ear set for you. The ER-4Ps boast a powerful bass boost, blowing away Etymotic's newer ER-6s. The included travel kit contains an extensive set of cleaning tools and spare parts, plus a quarter-inch jack for use with home stereo systems.

\$330, www.etymotic.com



↑ WIRED

Bumpin' low end. Custom-molded earpieces available. Different colors for left and right make pluggin' up a breeze.

↓ TIRED

High price for only pretty-good sound. Ugly. Thin wires.



CHEAP THRILL

◀ SHURE E3c

If spending \$300 or more seems ridiculous, Shure's newest model offers an affordable yet still high-quality alternative. The E3c's are clear, without exaggerated lows or highs, and bass notes don't wimp out as the volume increases. Extra sleeves in a variety of sizes and shapes ensure fit and comfort.

\$179, www.shure.com



↑ WIRED

Best boom for the buck.

↓ TIRED

Me-too white enclosures clearly an attempt to exploit the iPod craze, but the black cable and sleeves spoil the effect.



EDITORS' PICK

◀ ULTIMATE EARS UE-10 PRO

God's new favorite earphones. Twin woofers and a single tweeter – yes, three speakers in each little probe – deliver nearly perfect sound, even at high volume. The company custom-shapes each pair to match the contours of the wearer's ears. The result: The best-sounding buds ever.

\$900 (plus \$10-50 for ear molds), www.ultimateears.com



↑ WIRED

Loud and clear no matter what they're pumping. Perfect-fit design locks in place with surprising comfort. Custom colors available.

↓ TIRED

Costs more than two iPods. Shorter-than-average cable.



Noise-Canceling Headphones

Sound-zapping electronics are just the ticket for harried travelers. They take out a bustling terminal or a screaming baby to let you focus on your music.



◀ BOSE QUIETCOMFORT 2

These **cost-is-no-object** silencers feature a noise-reduction system so smooth it's like someone turned the world's volume down. Outside sounds aren't gone, they're just lower, without seeming filtered or processed. Meanwhile, music comes through a pair of precise, smooth transducers.

\$299, www.bose.com



↑ WIRED

Cozy padding lines earpieces and headband. Travel kit with adapters for wacky airplane jacks.

↓ TIRED

When the AAA battery dies, so does your music. Bulky for travel. Steep price for something you might leave on the plane.



◀ SONY MDR-G94NC

Smaller, lighter, and cheaper than Bose's clamorbusters, Sony's Vaio-esque headphones aren't as good at muting outside annoyances, partly due to their open design. But for cost-conscious frequent fliers who can't pack a full-size pair, they'll get the job done – without mussing the 'do.

\$70, www.sonystyle.com



↑ WIRED

Rear-headband design defies gravity and actually stays on head. Small and light for easy packing.

↓ TIRED

Middling sound and build quality. Edgy industrial styling looks hip to some, silly to others.

Headphones Scorecard

	Rating	Model	Price	Closed/Open	Circumaural/Supraural	Weight (ounces)
HI-FI	5	Grado RS-1	\$695	Open	Supraural	9
	4.5	Stax Signature System II	\$1,700	Open	Circumaural	16.9
	4	Sennheiser HD 555	\$170	Open	Circumaural	9.3
	3	Koss Pro3AA	\$70	Closed	Circumaural	10.6
SURROUND SOUND	4.5	Sony MDR-DS8000	\$799	Open	Circumaural	12.5
	3	Pioneer SE-DIR800C	\$399	Closed	Circumaural	8.9
	3	Zalman ZM-RS6F	\$70	Closed	Circumaural	11.3
IN-EAR	5	Ultimate Ears UE-10 Pro	\$900	N/A	N/A	Less than 1
	4	Etyimotic ER-4P	\$330	N/A	N/A	Less than 1
	3.5	Shure E3c	\$179	N/A	N/A	1
	1.5	Apple iPod In-Ear Headphones	\$39	N/A	N/A	Less than 1
NOISE-CANCELING	4.5	Bose QuietComfort 2	\$299	Closed	Circumaural	6.9
	3	Sony MDR-G94NC	\$70	Open	Supraural	3



HOUSEHOLD

Kitchen and Bath

Your PC is bleeding-edge, but your cooking and cleaning gear is way past dead. Time to upgrade those dull knives, singed pot holders, and more.

- 115 Super-Automatic Coffee Machines
- 116 Ceramic Chef's Knives
- 117 Oven Mitts and Gloves
- 118 Shower TVs and Radios

PLUS:
120 Robotic Vacuums

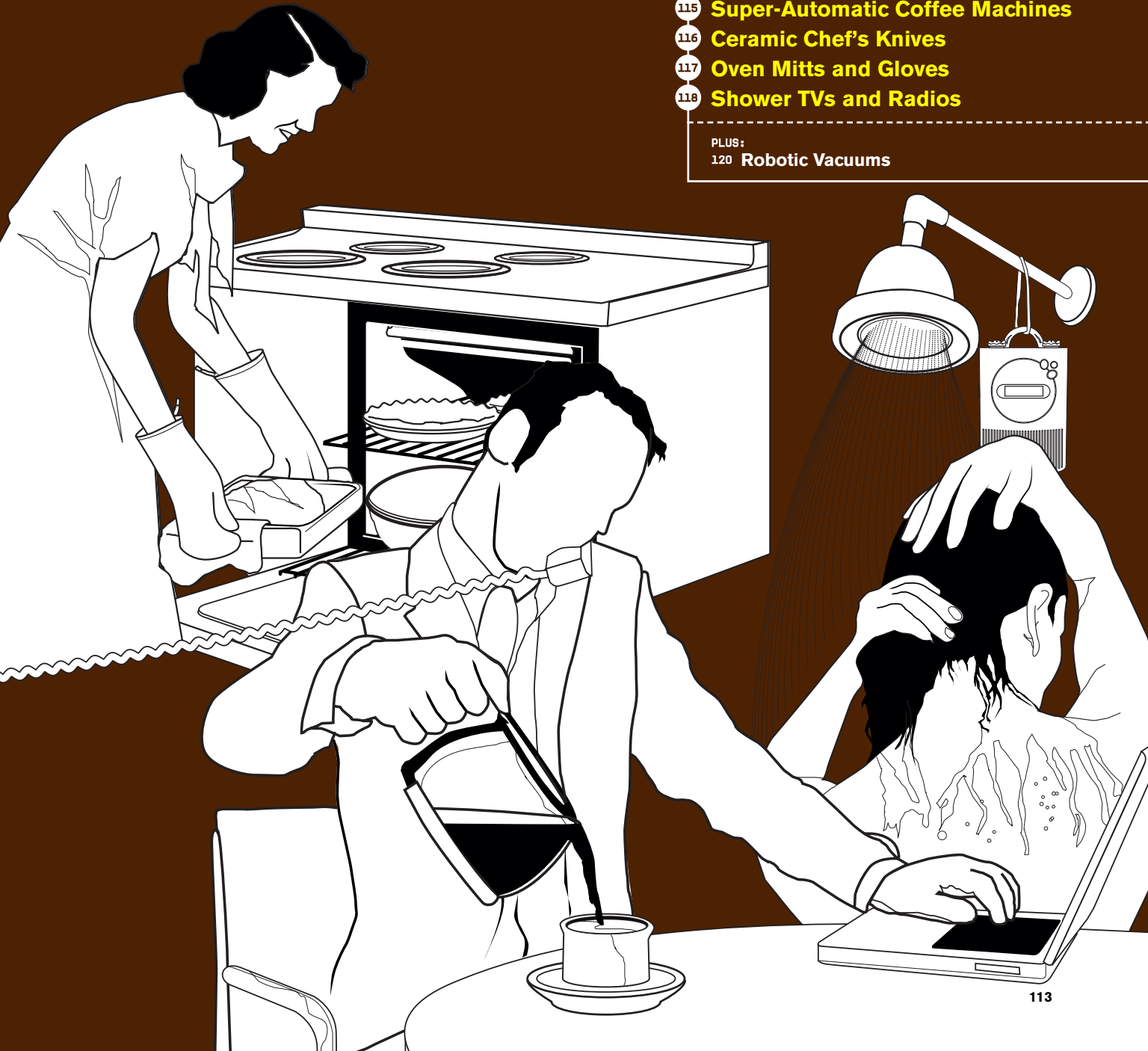

Kitchen and Bath Essentials

SUPER-AUTOMATIC COFFEE MACHINES ▼

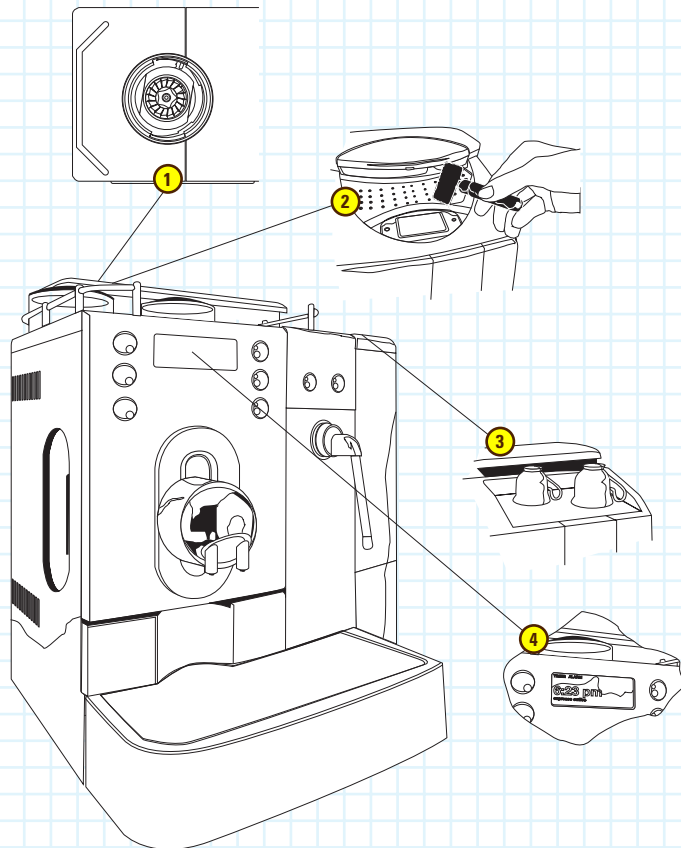

1 GRINDER

The flavor of coffee is affected by how the beans are ground. Burr grinders (in all machines we reviewed) deliver a more even batch than bladed ones, for consistent brews. They also emit less heat, which can cause bitterness.

2 BYPASS DOSER

You'll appreciate this feature most when you need to make a quick decaf for a guest. A funnel feeds ground coffee directly into the brew unit, so you can whip up a single cup without accessing the bean reservoir.

3 HEATED CUP TRAY

Connoisseurs claim a cold mug can ruin good coffee, so select systems come with a cup-warming tray. A quick squirt of hot water from the steam wand works just as well.

4 DIGITAL READOUT

Some super-automatic coffeemakers have an LED screen for displaying the time and brew settings; others talk to you with lights and illuminated symbols. The latter can be difficult to decipher.

OVEN MITTS AND GLOVES ▼

1 MATERIAL

Neoprene, silicone, and Kevlar all protect hands from heat (up to 480 degrees Fahrenheit). But Kevlar knit isn't impervious, so it can't guard against hot liquids like boiling water.

2 SHAPE

A five-fingered glove offers the wearer more dexterity than a semi-rigid mitt. Extra-long models cover you up to the elbow as you grab for that lobster at the bottom of the pot.

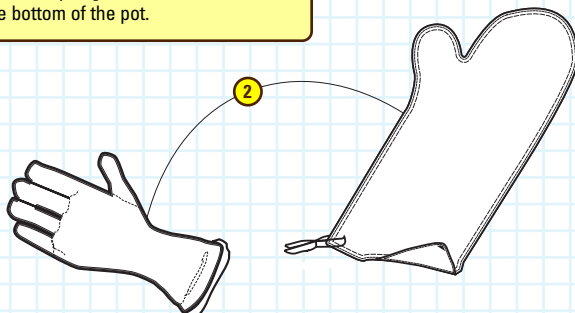
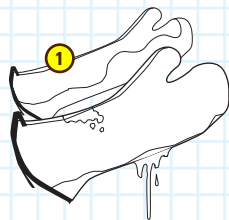

CERAMIC CHEF'S KNIVES ▼

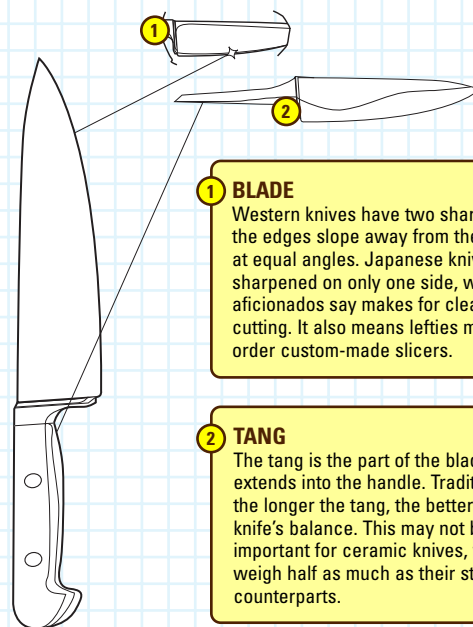

1 BLADE

Western knives have two sharp sides; the edges slope away from their peak at equal angles. Japanese knives are sharpened on only one side, which aficionados say makes for cleaner cutting. It also means lefties must order custom-made slicers.

2 TANG

The tang is the part of the blade that extends into the handle. Traditionally, the longer the tang, the better the knife's balance. This may not be as important for ceramic knives, which weigh half as much as their steel counterparts.



Super-Automatic Coffee Machines

Load beans into these ultra-programmable units, and they'll grind, tamp, and brew the perfect cup of coffee or espresso every time. – Lucas Graves



◀ JURA-CAPRESSO IMPRESSA E8

Of all the models tested, the Impressa was the most compact and easiest to operate. More important, it delivered rich java and frothy milk that held up against all comers. It deftly bridged the coffee-espresso divide, serving single shots and mugs o' mud on demand.

\$999, www.cappresso.com



↑ WIRED

The only machine that supports an in-tank water filter. It has a bypass doser that skips the bean reservoir to brew a single cup of a different grind.

↓ TIRED

Water temperature can't be fine-tuned.



◀ MIELE COFFEE SYSTEM CVA615

All the high-end automatics put drip pots to shame, but if you really want to steam past the Joneses (and money is no object), check out this rig from Miele. Designed to be set into a kitchen cabinet, its largesse becomes a statement: No one worships the coffee bean more than you.

\$1,999 and up, www.miele.com



↑ WIRED

Chock-full of features but a cinch to use – once you get the thing installed. Face swings open for easy access to water and beans. Sexy design may rub off on you.

↓ TIRED

Mad expensive – especially since Miele forgot to include a bypass doser.



◀ SAECO V'SPRESSO

The V'spresso starts with the best elements of cheaper models and fills in the gaps: a bypass doser, a compact frame, and a relatively clear instruction manual. It also has a heated tray to keep your mugs warm. But the Saeco costs a lot – even more than the Jura-Capresso, which matches it on most key features.

\$1,300, www.saeco-usa.com



↑ WIRED

Easy setup. Compact. Bypass doser, adjustable water temperature, and heated cup tray give it the fullest feature set of any tabletop machine tested.

↓ TIRED

The extras give it the fullest price of any tabletop machine tested.



◀ SPIDEM TREVI DIGITAL PLUS

Spidem's silver super-automatic looks cool and is a breeze to set up. And thank goodness, because deciphering the installation instructions is another story. And it has the same technology inside (by Saeco) as more expensive models, at almost half the price.

\$679, www.spidem.it



↑ WIRED

Brews fine coffee for hundreds of dollars less than the others. Convenient side panel for dumping grounds (no need to open the main unit). Temperature controls.

↓ TIRED

Huge footprint. No bypass doser. Manual reads like the ancient text of a secret coffee cult.

Ceramic Chef's Knives

Has metal lost its mettle? We had New York chef Wylie Dufresne put some ceramic blades through their slices at wd-50, his Lower East Side eatery. – L.G.



◀ BOKER CERA-TITAN III

The new titanium and ceramic Cera-Titan III was the best overall value and the sharpest of the models tested – a sous chef at wd-50 called it “wicked sharp.” After a week in heavy rotation, this 6.25-incher still sliced a sheet of notebook paper effortlessly. But the plastic handle makes the knife feel somewhat blade-heavy.

\$115, www.bokerusa.com



↑ WIRED

Supersharpest blade keeps its edge. Alloy blend (unlike pure ceramics) means it can be sharpened at home. Sports distinctive, cleaver-like “deba” shape. Low price.

↓ TIRED

Light plastic handle can get slimy and makes balance awkward.



◀ KYOCERA KYOTOP KT-165-HIP

Kyocera’s gorgeous, wood-handled knife was the best performer of the bunch, with a razor-sharp zirconium-oxide edge, good balance, and a comfortable handle. This is the one ceramic knife Dufresne says he would add to his arsenal – if someone else were paying the tab. (Note: Our pro cooks found Kyocera’s \$90 budget model too light and slick.)

\$300, www.kyoceraadvancedceramics.com



↑ WIRED

Excellent 6.25-inch blade, second only to the Cera-Titan in sharpness – and not by much. Wood handle places it a cut above the rest in balance, heft, and looks.

↓ TIRED

Cut above in price, too.



◀ URI EAGLE BLACK DIAMOND CERAMIC 6-INCH CHEF'S KNIFE

This bargain blade is fine for casual cooking but not for fast-paced professional use. Dufresne said its poor balance and lack of weight “freaked the cooks out.” Even straight out of the box, the edge was dull, which can cause accidents in the kitchen as cooks compensate with extra force.

\$108, www.urieagle.com



↑ WIRED

Affordable for a ceramic blade. More than enough knife for the home chef who sticks to basics like chopping vegetables.

↓ TIRED

Not the sharpest knife in the drawer. For a few dollars more, the Boker is a much better deal.

QUICK TIP

If you want to keep your knives sharp, store them separately in protective sheaths.



Oven Mitts and Gloves

With today's stoves packing bigger, hotter grills, home cooking is more dangerous than ever. These mitts keep the sizzle off your skin. – Philip Ferrato



◀ DUNCAN INDUSTRIES KITCHEN GRIPS MITT

This **synthetic rubber** mitt offers plenty of room for big hands and a nicely turned-back cuff. The glove comes in two lengths and a variety of styles; some models are waterproof and submersible. Sturdy and user-friendly, this cousin of the neoprene wet suit is dishwasher safe.

\$15 and up, www.kitchengrips.com



↑ WIRED

Heavy-duty protection up to 500 degrees Fahrenheit. Supple enough to grasp tongs and tools.

↓ TIRED

New gloves emit a strong petroleum odor (which quickly abates).



◀ iSi ORKA

A **chic**, French-designed mitt with stamina, the Orka is beefy enough for long grilling sessions. It also possesses a witty, anthropomorphic profile suitable for post-dessert puppet shows. Its sleek molded silicone is a direct descendant of Silly Putty.

\$20, www.surlatable.com



↑ WIRED

Dives into boiling liquids easily – protects just long enough to grab a lobster or an errant kitchen tool. Available in five colors and an extra-long, heavy-duty model.

↓ TIRED

Snug fit on wide hands and thick forearms.



◀ JOSEPH ENTERPRISES OVE GLOVE

This **classic fingered** glove is made of a pliable Kevlar and Nomex knit – the same flame-retardant material used in suits worn by firefighters and race car drivers. It's comfy protection for handling hot cookware – up to 480 degrees Fahrenheit.

\$15, www.oveglove.com



↑ WIRED

Fits either hand. Cotton-lined. Machine washable.

↓ TIRED

Knit offers no protection from hot liquids or sharp objects.

QUICK TIP

Keep your mitts where you can see them, so you won't be tempted to use a dish towel instead.

Shower TVs and Radios

If the bathroom is the one place you go to escape technology, stop reading now. This gear adds audio and video to your hygiene routine. – L.G.

TVs ▼



◀ CASIO XFER XF-1000

Casio's slim, lightweight, 10-inch wireless LCD can bring Katie Couric into your shower in vivid color (it'll even survive a quick dunk in the tub). But it looks so cool you'll want to tote it around the house. Until next summer, it's available only from importers, but fear not – we got it going in five minutes without even trying to crack the Japanese manual.

\$1,399, www.dynamism.com



↑ WIRED

Good looks, smart design, solid feel. Foldout stand. Universal remote and transmitter with built-in cable tuner and dual video inputs.

↓ TIRED

Video resolution tops out at 640 x 480 pixels. High price. Japanese interface.



◀ SHARPER IMAGE TV SHOWER COMPANION

Sharper Image's utilitarian contender for splash-proof video is less than a fourth the price of Casio's XF-1000; unfortunately it's about a fourth the machine, too. Though the small LCD (3.5 inches) provides a crisp image, the bulky body and crude styling will have you singing forlornly in the shower.

\$300, www.sharperimage.com



↑ WIRED

Wireless transmitter unit with built-in cable tuner and composite video. Easy setup. Rechargeable. A/V-out port to view on a bigger monitor. Affordable.

↓ TIRED

Bulky body for such a small screen. No remote. Limited use outside the loo.

RADIO/CD PLAYERS ▼



◀ JENSEN JCR-550 SHOWER CLOCK RADIO & CD PLAYER

We like this model for its fog-resistant mirror, which seems like a smart thing to add to a shower radio. And it is – too bad the rest of the unit doesn't quite keep up. The analog tuner (AM/FM) is awkward, and the sound is slightly tinny. Still, for the price you could do a lot worse.

\$60, www.spectraintl.com



↑ WIRED

Big, crisp, fog-resistant mirror. Headphone jack – though we don't recommend using it while washing your hair. Budget option for bringing music to your bath.

↓ TIRED

No radio presets. No skip protection – so don't bump it. Top-heavy design. Poor sound.

QUICK TIP

Make sure your shower player can handle CD-Rs. That way, you can croon to your own mix of tunes.



◀ SONY LIV 4-BAND SHOWER CD CLOCK RADIO

For high-quality shower sing-alongs, Sony's Liv is the way to go. It has cleaner, richer sound than the Jensen, not to mention a rugged, compact body. Plus you can work the easy-to-open clasps and smart digital interface even with soap in your eyes.

\$80, www.sonystyle.com



↑ WIRED

Five station presets, simple radio tuning, countdown timer, and one-touch operation. Solidly built. AM/FM/CD. Weather bands.

↓ TIRED

No fog-resistant mirror. A wee bit pricey. No skip protection.

Kitchen and Bath Scorecard

Rating	Model	Price	Body Style	Grinder Features	Additional Features
4	Jura-Cappresso Impressa E8	\$999	Compact	Burr grinder, bypass doser	Supports water filter
3.5	Miele Coffee System CVA615	\$1,999 and up	Built-in	Burr grinder	Optional heated cup drawer, adjustable water temperature
3.5	Saeco V'spresso	\$1,300	Compact	Burr grinder, bypass doser	Heated cup tray, adjustable water temperature
3	Spidem Trevi Digital Plus	\$679	Standard	Burr grinder	Easy-access grounds drawer, adjustable water temperature

Rating	Model	Price	Blade Style	Blade Material	Additional Features
4	Boker Cera-Titan III	\$115	Japanese	Titanium alloy	POM plastic handle, "deba" shape
3.5	Kyocera Kyotop KT-165-HIP	\$300	Western	Hot isostatic pressed zirconium oxide	Pakka wood handle, rosewood case
3	URI Eagle Black Diamond Ceramic 6-inch Chef's Knife	\$108	Western	Black zirconium carbide	ABS plastic handle

Rating	Model	Price	Temperature Rating	Material	Additional Features
5	Duncan Industries Kitchen Grips	\$15 and up	500°F	Synthetic rubber	Resists water and other liquids (oil splashes); safe for dry ice, dishwasher, and washing machine
4	iSi Orka	\$20	500°F	Silicone	Waterproof, safe for hot oil, fits either hand, multiple colors available
3	Joseph Enterprises Ove Glove	\$15	480°F	Kevlar and Nomex	Knitted glove fits either hand

Rating	Model	Price	Screen Size / Resolution	Sources	Additional Features
4	Casio XFER XF-1000	\$1,399	10 inches / 640 x 480	VHF/UHF/cable tuner, S-video, composite video	Rechargeable
2	Sharper Image TV Shower Companion	\$300	3.5-inches / 320 x 240	VHF/UHF/cable tuner, composite video	Video-out jack, rechargeable
4.5	Sony Liv 4-Band Shower CD Clock Radio	\$80	N/A	CD, AM/FM, TV audio, weather band	Station presets
3	Jensen JCR-550 Shower Clock Radio & CD Player	\$60	N/A	CD, AM/FM	Fog-free mirror



Robotic Vacuums

Drop that upright! A robovac will suck up crumbs, lint, and grit – then return to its base for a recharge. You don't have to lift a finger. – **Bob Parks**

iROBOT ROOMBA DISCOVERY SHOWN

Older Roombas pale in comparison to the new Discovery. It features a larger debris bin, longer battery life, and ultrasonic sensors for Dirt Detect mode: If it finds a super-soiled spot, the bot stays in the area until it's cleaned, then returns to its charger and awaits new commands. Its whiskerlike side brush swept crumbs from wall edges and even lapped up big items like blueberries.

\$250, www.irobot.com

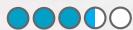

KARCHER RC3000 ROBOCLEANER

This Hoover goes from room to room and doesn't make a racket. It autodocks every 20 to 60 minutes, recharges, and empties its load into a spacious 2-liter bag in the base unit. But sucking power is low, so it won't pull crumbs out of a medium-pile carpet. What it will suck are dollars, right out of your pocket.

\$1,495, www.karcher.com/usa



ELECTROLUX TRILOBITE

Ultrasound guides the Trilobite to within a fraction of an inch of chair legs and walls. It circumnavigates baseboards, while a top-mounted LCD counts down estimated cleaning time based on room size. But the machine often fails to dock into its charger – and for this price, we expect better service.

\$1,799, www.electroluxusa.com





COMPUTING AND GAMING

Laptops

Why buy a desk hog when many portables pack the same horsepower? These models do games, movies, and more. **by Paul Boutin**

- 125 **Thin-and-Light Laptops**
- 126 **Tablet PCs**
- 127 **Multimedia Laptops**
- 130 **Gaming Laptops**
- 131 **Ruggedized Laptops**

PLUS:
132 **Programmable Robot Kits**



Laptop Essentials

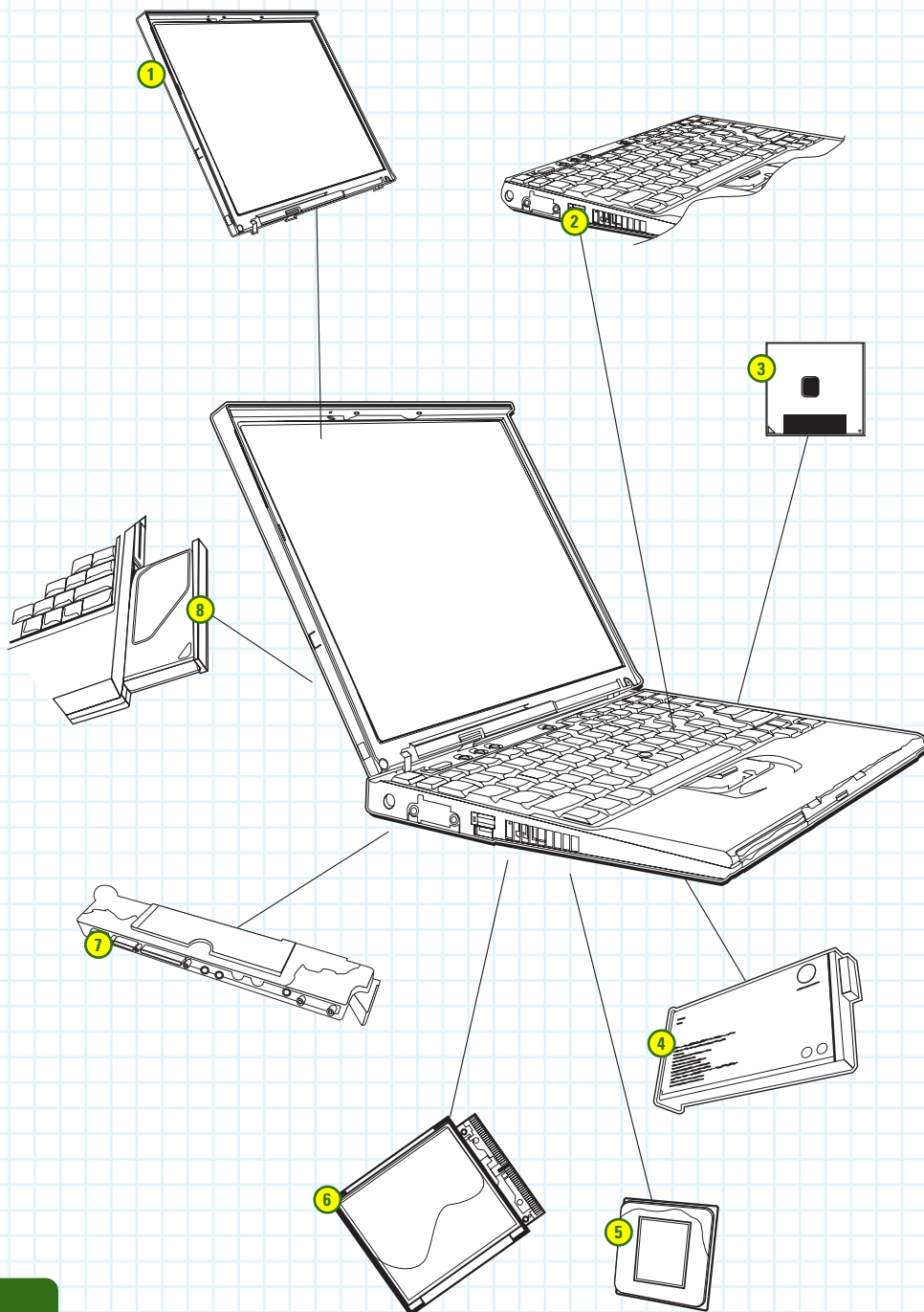

1 DISPLAY

Get the brightest you can afford. Widescreens are great for watching DVDs or viewing windows side by side. A 12-inch, 1,024 x 768-pixel display is OK, but if you plan to use the laptop as your main computer, go for at least 1,280 pixels and 14 inches across.

2 KEYBOARD

Be sure you can type comfortably. Some models resort to undersize or poorly placed keys to save on space.

3 PROCESSOR

For PCs, Intel's Pentium M (a.k.a. Centrino) chip is fast and efficient, which helps prolong battery life. If power consumption isn't a major concern, Intel's Pentium 4 or AMD's Athlon 64 CPU is fine. Mac users get only one choice: the G4.

4 BATTERY

Budget an extra \$100 to upgrade the standard battery, add a second, or get a spare to carry along.

5 GRAPHICS CHIP

If you're not a gamer, don't sweat this component. If you are, ATI's Radeon 9800 processor beats all comers. But don't lock yourself into today's tech. Look for a laptop that you can upgrade.

6 WI-FI

Wireless capability is a must for staying connected wherever you are. Don't mess with aftermarket cards; get a laptop with Wi-Fi built in.

7 DOCKING

Some laptops plug into docks or port replicators, letting you hook up a raft of peripherals (keyboard, printer, monitor) with a single connection. Docking stations contain optical drives, extra batteries, or better speakers, so you can keep your notebook truly portable.

8 MODULAR BAY

One of these lets you swap components in and out (DVD burner, auxiliary battery) so you don't have to weigh down your machine with every option under the sun.



Thin-and-Light Laptops

These petite performers cram maximum specs into minimum space, letting you carry your workload everywhere without breaking your back.



DELL INSPIRON 700m

The 700m tore through our CD-ripping exercise in five minutes flat, thanks to its 1.8-GHz Pentium M processor. Plus, the 12.1-inch widescreen delivers generous 1,280 x 800 resolution. But Dell's machine ran hotter than other thin-and-lights, and the power ran dry in two hours (you can purchase a double-size battery for \$59 extra).

\$2,091, www.dell.com



↑ WIRED

Fast. Wide, hi-res screen is great for displaying movies played from the onboard DVD-burning drive.

↓ TIRED

Cramped keyboard makes heavy text work difficult. Mundane styling. Unit too hot against wrists and lap.



FUJITSU LIFEBOOK P7000

It's amazing what Fujitsu crams into a 3.3-pound, 11 x 8-inch PC. Cool features include a DVD-ROM/CD-RW drive, slots for CF and SD memory cards, FireWire and S-video ports, 802.11a/b/g networking, and a battery that lasts 2.5 hours. The wide viewing angle of the 10.6-inch, 1,280 x 768 display is perfect for in-flight movies.

\$1,999, www.us.fujitsu.com



↑ WIRED

Complete PC in a book-sized package. Disc drive can be hot-swapped for a second battery. Hi-res display with wide viewing angle makes it seem even bigger.

↓ TIRED

Crowded keyboard. Squinty-small screen for text work. Unglamorous looks. Nearly 1.5 inches thick.



IBM THINKPAD X40 23826UU

If your laptop is your life, meet your soul mate. The ThinkPad's keyboard is better than many desktops', and the four-hour life of its standard battery was the best in our tests. The latest model has an updated TrackPoint with alternate finger grips. Performance is respectable: It ripped a CD to AAC files in an even six minutes.

\$2,324, www.ibm.com



↑ WIRED

Executive chic. Outstanding keyboard and battery life. Nice balance and feel in your lap. Keyboard lamp for red-eye flights. Underside stays cool.

↓ TIRED

Executive price tag. Smallish 1,024 x 768 screen. Optical drive in heavy travel dock.



SHARP ACTIUS MM20P

It's no all-day workhorse, but the MM20P is barely thicker than its Ethernet jack – a plus for PowerPoint jockeys rushing between sales calls. The included dock syncs files with a desktop PC – or a larger laptop. Switching from Normal to Mobile mode boosted battery life from 90 minutes to nearly three hours but dimmed the screen considerably.

\$1,599, www.sharpsystems.com



↑ WIRED

Slim and stylish. Cradle mounts unit to host computer as external drive for easy syncing. Built-in universal 802.11 Wi-Fi.

↓ TIRED

Lackluster battery life. Installing software via dock is confusing. (Planned successor will have a built-in optical drive.)

Tablet PCs

Tap or type? Top-notch tablets let you do both. They couple Microsoft's steadily improving handwriting-recognition software with full keyboards.



◀ MOTION COMPUTING M1400

This **clipboard-sized** PC has the jacks, card slots, modem, Pentium M processor, and Wi-Fi you'd expect in a laptop. (A DVD drive plugs in via USB.) Stylus input is a breeze on the bright 1,024 x 768 screen, while hunt-and-peckers choose from two types of attachable keyboards. **\$2,351, www.motioncomputing.com**



↑ WIRED

Comfortable, balanced feel. Three-hour battery life (with keyboards detached). One keyboard doubles as a lid for the 11.7-inch screen.

↓ TIRED

Optical drive not built in. Too many parts to lose.



◀ TOSHIBA PORTÉGÉ M205-S810

The **display** on this handsome laptop swivels around, Transformer-style, and locks into place over the keyboard to create a tablet with about the same width and height as Motion's M1400. But don't kid yourself: Carried in one hand, it lacks the balance of a standard slate design. **\$2,299, www.toshiba.com**



↑ WIRED

Power and convenience of a laptop with optional tablet mode. Hi-res 1,400 x 1,050 display.

↓ TIRED

Two-piece body, 1.5-inch thickness, and 4.5-pound weight contribute to clumsy feel.

How to Choose the Right Laptop

It all comes down to what you get – and what you give up. Here's a rundown of the trade-offs.

THIN-AND-LIGHT

WHAT YOU GET: Freedom. Workaholics savor the hours of productivity on planes and trains, and a PC that opens wide in even the tightest settings – like that coach airline seat when the guy up front reclines.

WHAT YOU GIVE UP: Comfort. Gone are the large screen and spacious keyboard – and possibly the optical drive. Back in the office, plug in a proper monitor and keyboard for computing-intensive tasks.

TABLET

WHAT YOU GET: Flexibility. You can work on your résumé while standing, and handwriting recognition turns scribbled notes into typed out, searchable text.

WHAT YOU GIVE UP: A keyboard. True tablets become crappy, clumsy laptops when you go QWERTY with them. Plus, they often have wimpy components to conserve power and weight. Convertibles have two modes: awkward tablet and pricey laptop.

MULTIMEDIA

WHAT YOU GET: Eye candy. A giant screen looks great, especially with the *Star Wars* trilogy playing out across it. It also requires a larger case, leaving space for a roomier keyboard and better airflow to keep the system cool.

WHAT YOU GIVE UP: Mobility. A 10-pound notebook the size of an atlas isn't one you're going to tote idly to the coffeehouse or use on your lap for hours. And if you're crazy enough to travel with it, you won't have the real estate to open it unless you're flying first class.

GAMING

WHAT YOU GET: Raw power. Brilliant screens and screaming graphics now come in small, semiportable packages. And lugging your laptop to a LAN party beats schlepping a tower or playing alone.

WHAT YOU GIVE UP: Your cool. Gaming machines put burning-hot hardware below your wrists. They're also less upgradable than their desktop brethren; you may be able to swap in a new graphics system, but not a motherboard.

RUGGEDIZED

WHAT YOU GET: Invincibility. These tough customers endure harsh weather, turbulent travel, and acute clumsiness.

WHAT YOU GIVE UP: Luxury. Shock-proofing, protective body armor, and the demands of durability all add up to less room for features like hi-res screens and speakers. Ruggedized keyboards and touchpads are less comfortable to use than those found on standard notebooks. – P.B.



Multimedia Laptops

These portable theaters merge rich, sometimes widescreen displays with full-featured audio and video software. Tired of Hollywood's flicks? Create your own.



◀ APPLE POWERBOOK G4 (17-INCH)

Software is the real strength of this sleek, light-weight aluminum slab. Built-in apps for editing and managing photos, videos, music, and custom DVDs work together smoothly. And Apple's OS X is less targeted by viruses, worms, and spyware than Microsoft's – a nice plus.

\$2,799, www.apple.com



↑ WIRED

An inch thick and less than 7 pounds. Three-hour battery life. Backlit keyboard and comfy, scalloped keys.

↓ TIRED

Limited choice of third-party apps. Pixel-poor 1,440 x 900 screen.



◀ FUJITSU LIFEBOOK N5010

If it shed a few pounds and got a new wardrobe, the N5010 would be a winner. Audio perks include the Dolby Headphone system, which simulates 5.1 surround sound on stereo cans. The best nod to its home theater aspirations: the volume knob above the keyboard.

\$2,349, www.computers.us.fujitsu.com



↑ WIRED

Lap-friendly for a 16-incher. Affordable.

↓ TIRED

Obese at 10.4 pounds. Two-tone case looks clunky. Narrow display.



◀ SONY VAIO VGN-A190

Kill your television – or this 17-inch widescreen monster will. The VGN-A190's A/V dock has a built-in TV tuner. Use the remote to channel-surf, then launch Sony's recording software to dub *Nip/Tuck*. Plug in the included speakers and blast the soundtrack from the dock's digital amp.

\$2,700, www.sonymstyle.com



↑ WIRED

Screen brightness auto-adjusts to ambient light. The 11-inch-high speakers are a bonus.

↓ TIRED

Keyboard and buttons hard to see in the dark. CD ripping took an excruciating 13 minutes.

Laptops How We Tested

ALL LAPTOPS



BATTERY LIFE

In place of lab-optimized tests, we simulated real-life use by running the screen at maximum brightness while playing digital music files to steadily but moderately tax the processor and hard drive.



CD RIPPING

We encoded Mos Def's 17-track CD *Black on Both Sides* into 128-Kbps AAC music files with iTunes. This number-crunching task mainly stresses the processor, but the optical drive also affects performance.

MULTIMEDIA



VIDEO CONVERSION

On PCs, we used Adobe Premiere Pro 1.5 to convert an AVI file to the MPEG-2 format.



IMAGE CONVERSION

We used Adobe Photoshop CS to compress a 110-Mbyte PSD file into a 7.5-Mbyte GIF.

GAMING



GRAPHICS PERFORMANCE

We measured frame rates while playing *Far Cry* and *Unreal Tournament 2004* at resolutions of 1,024 x 768, 1,280 x 1,024, and 1,600 x 1,200.

COMPUTING AND GAMING LAPTOPS

Gaming Laptops

Portable PCs optimized for gaming wrap flashy case designs around pedal-to-the-metal hardware, so you can take the battle to the enemy in style.



◀ DELL INSPIRON XPS

This behemoth trounced all comers, thanks in large part to ATI's screaming (and upgradable) Radeon 9800 graphics processor. Even *Far Cry* ran at a fluid 37 frames per second with 1,280 x 1,024 resolution, while *Unreal* hit 103 fps – both way ahead of the rest. And the XPS stays cool when the action gets hot.

\$3,404, www.dell.com



↑ WIRED

Detailed 1,920 x 1,200 display. Special tech support line separates gamers from regular Dell dudes for better service.

↓ TIRED

One-hour battery life. Pricey. Black lid with skull emblems about as punk rock as Avril Lavigne.



◀ FALCON NORTHWEST FRAGBOOK DR

Like a Harley, our FragBook ran hot, loud, and fast, while sporting a custom Stars and Stripes paint job on the lid. Falcon specializes in one-off finishes and case mods, both tasteful and tacky. And it guarantees no defective pixels on the 1,680 x 1,050 display, which nonetheless lacked the cinematic quality of Gateway's for games.

\$4,995, www.falcon-nw.com



↑ WIRED

Pulled through *Far Cry* at 24 frames per second – just above average for 1,280 x 1,024 resolution. Upgradable graphics. Voluminous 120 gigs of hard disk space.

↓ TIRED

Abysmal 45-minute battery life. Fan kicks into noisy high-speed mode for games. A porker at 11.3 pounds.



◀ GATEWAY M675XL

Its styling may be reserved, but the Gateway's performance matches the gaudier hot rods mile for mile. Most important, its lush 1,680 x 1,050 display brought *Far Cry* to life better than any other. Frame rates from the Radeon 9700 chip were solid – 70 per second for *Unreal*, and 21 for *Far Cry* at 1,280 x 1,024.

\$2,799, www.gateway.com



↑ WIRED

Gorgeous display helped deliver best overall gaming experience. Sleek design, solid build. Buttons on front panel for playing CDs and DVDs.

↓ TIRED

No match for Dell Inspiron on frame rates. Graphics system not upgradable. One-hour battery life.



◀ VOODOO ENVY m:860

If head-turning looks matter more to you than neck-snapping speed, your search ends here; Voodoo's high-gloss finish upstages them all. The onscreen graphics were less impressive, with 19 fps in *Far Cry* at 1,280 x 1,024. But the Athlon 3400+ CPU may blow past the others when 64-bit games arrive in late 2004 or early 2005.

\$3,200, www.voodoopc.com



↑ WIRED

Sexy lacquered finish. Athlon 64-bit CPU will soon run optimized games.

↓ TIRED

At 1,680 x 1,050 and 15 inches, the screen lacks the depth and dimensions of Gateway's larger LCD.



Ruggedized Laptops

Shock-absorbing cases, coffee-proof keyboards. Whether used on the factory floor or dropped from the dining room table, these road warriors are built to last.



EDITORS' PICK ✓

◀ PANASONIC TOUGHBOOK Y2

It's not mil-spec – Panasonic's sturdy notebook was built to withstand the hazards of business travel. Miraculously, it weighs an ultralight 3.4 pounds, and the magnesium alloy case has a dent-resistant lid. Other high points: a 14.1-inch 1,400 x 1,050 display and 1.3-GHz Pentium M CPU.

\$2,550, www.panasonic.com



↑ WIRED

Unbelievably light. Silver exterior stylish enough for sales presentations yet durable enough to survive airport security.

↓ TIRED

Tinny speakers. Jacks and bays not protected from the elements.



◀ KONTRON REVOLUTION

This convertible laptop and tablet functions in the rain and in temperatures from 5 to 140 degrees. The magnesium case holds two large bays – each with a watertight door – for field hardware, all-day batteries, or a DVD drive. The 12.1-inch screen is a modest 1,024 x 768 pixels.

\$3,395, www.kontron.com



↑ WIRED

Survived a 3-foot drop onto a concrete floor while running. Has two big, rubberized handles.

↓ TIRED

At 8 pounds, puts the heavy in heavy-duty. A price that only the Pentagon could love.

Laptops Scorecard

	Rating	Model	Price	Processor	RAM (Mbytes)	Screen (inches) / Resolution (pixels)	Hard Disk (Gbytes)	Battery Life (hours)	Weight (pounds)
THIN-AND-LIGHT	4.5	✓ IBM ThinkPad X40 23826UU	\$2,324	1.2-GHz Pentium M	512	12.1 / 1,024 x 768	40	4:03	2.7
	4	Fujitsu LifeBook P7000	\$1,999	1.1-GHz Pentium M	512	10.6 / 1,280 x 768	60	2:28	3.3
	4	Sharp Actius MM20P	\$1,599	1-GHz Transmeta 8600	512	10.4 / 1,024 x 768	20	1:31	2
	3	Dell Inspiron 700m	\$2,091	1.8-GHz Pentium M	512	12.1 / 1,280 x 800	60	2:09	4.1
TABLET	4.5	✓ Motion Computing M1400	\$2,351	1.1-GHz Pentium M	512	11.7 / 1,024 x 768	40	2:59	3
	4	Toshiba Portégé M205-S810	\$2,299	1.5-GHz Pentium M	512	12.1 / 1,400 x 1,050	60	2:16	4.5
MULTIMEDIA	4.5	✓ Sony Vaio VGN-A190	\$2,700	1.7-GHz Pentium M	512	17 / 1,920 x 1,200	80	1:36	8.6
	4	Apple PowerBook G4	\$2,799	1.5-GHz PowerPC G4	512	17 / 1,440 x 900	80	3:12	6.9
	3	Fujitsu LifeBook N5010	\$2,349	3.2-GHz Pentium 4	1,024	16.1 / 1,600 x 1,200	80	2:27	10.4
GAMING	4.5	✓ Gateway M675XL	\$2,799	3.4-GHz Pentium 4	1,024	17.1 / 1,680 x 1,050	80	1:04	9
	4	Dell Inspiron XPS	\$3,404	3.4-GHz Pentium 4	1,024	15.4 / 1,920 x 1,200	60	1:05	9.1
	4	Voodoo Envy m:860	\$3,200	2.2-GHz Athlon 64 3400+	1,024	15.4 / 1,680 x 1,050	60	1:31	8
	3	Falcon Northwest FragBook DR	\$4,995	3.4-GHz Pentium 4	1,024	17 / 1,680 x 1,050	120	0:45	11.3
RUGGED	4.5	✓ Panasonic Toughbook Y2	\$2,550	1.3-GHz Pentium M	256	14.1 / 1,400 x 1,050	40	3:14	3.4
	4	Kontron Revolution	\$3,395	1.1-GHz Pentium 4	640	12.1 / 1,024 x 768	60	3:32	8



Programmable Robot Kits

These bots look like remote-control cars, but with a little programming and some imagination, they become sumo wrestlers, off-road joyriders, or firefighters. – Peter Arcuni

SUPERDROID ROBOTS TREKKER FIRE FIGHTER

This SuperDroid Trekker can detect candle flames with its UVTRON sensor and extinguish them with an onboard fan. Beware: Putting this beast together makes Ikea furniture assembly seem fun. The sample code is easy enough to download but hard for a novice to grok. **\$599, www.superdroidrobots.com**

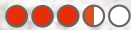

ROGUE ROBOTICS ATR ERS

The "ATR" stands for all-terrain robot. This little 'dozer can lunge over small objects, sidestep road-blocks, even run from light. It's easy to build and seriously expandable. But the wheel bands fall off around some turns and could use more horsepower. **\$295, www.roguerobotics.com**

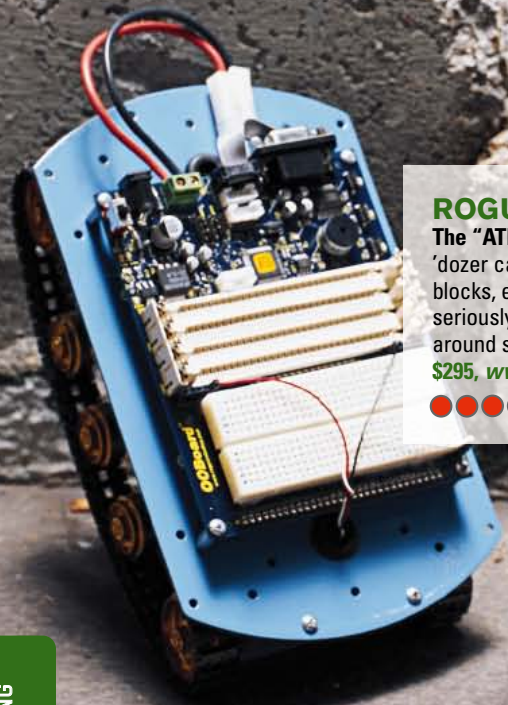

PARALLAX SUMOBOT

The SumoBot kicks serious robo-ass. With the help of a pair of edge detectors and two infrared sensors, it can navigate a tournament ring, track opponents, and muscle them out of bounds. SumoBot is beginner-friendly, but sophisticated coding and circuitry should please robo-geeks. **\$149, www.parallax.com**

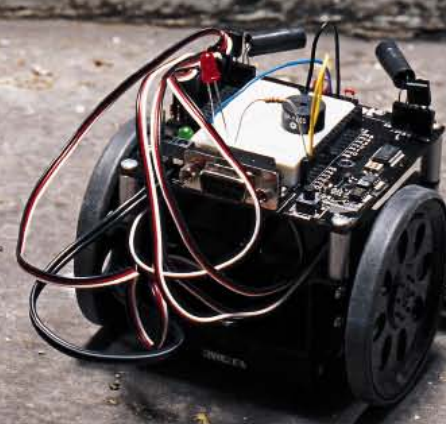



COMPUTING AND GAMING

Specialty PCs

Beige boxes are fine for spreadsheets, but frag fests and streaming video-thons need hardware with major muscle. **by Brian Lam**

135 **Gaming PCs**

136 **Media Center PCs**

PLUS:

138 **Wireless Desktop Sets**

139 **USB Gadgets**



Specialty PC Essentials

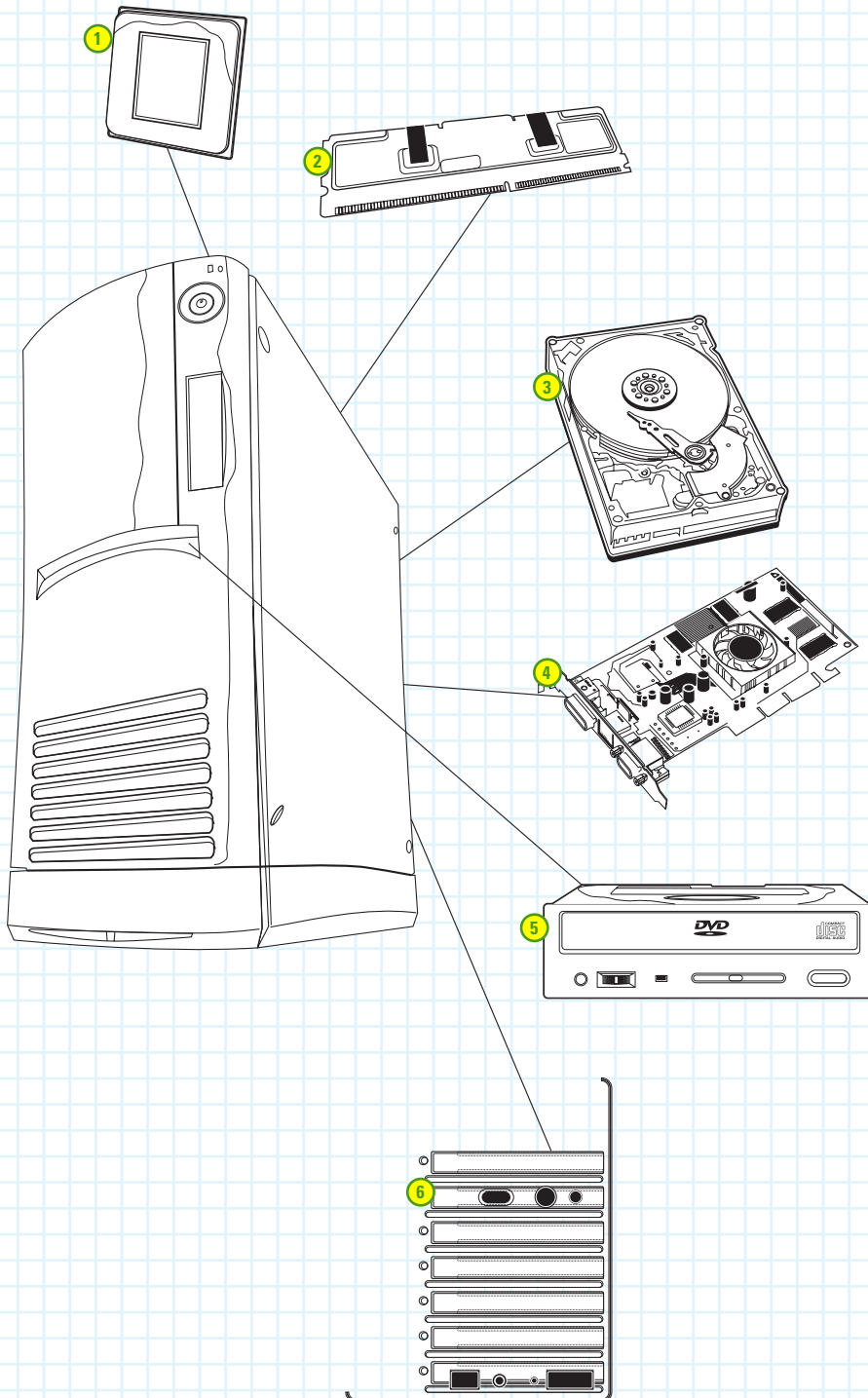

1 PROCESSOR

The 64-bit AMD Athlon is king – especially for gaming. For most other tasks, a 3-GHz Pentium 4 should give you more than enough muscle.

2 RAM

Anything less than 512 megs and your system could choke while running multiple memory-hogging applications or opening large files clogged with photos, video, or game levels.

3 HARD DISK

Get a serial ATA drive spinning at 7,200 rpm or faster with at least 160 gigs for holding all those movies, photos, and MP3s. Multiple drives running in tandem through a RAID configuration maximizes data-transfer speed.

4 GRAPHICS SYSTEM

For fast gaming action, get at least 128 megs of video RAM and support for the DirectX 9 gaming interface.

5 OPTICAL DRIVE

A standard DVD burner lets you make 4.7-Gbyte backups, but a dual-layer device gives you twice the storage. A second DVD drive is handy for making quick copies of discs. At press time, 16X is the fastest speed available, although even 12X is very quick.

6 EXPANSION SLOTS

PCI Express is beginning to replace the slower PCI and AGP card standards. Having the latest upgrade options helps future-proof your system.



Gaming PCs

If lightning-fast frame rates and sizzling CPUs get your blood up, you want a PC with the guts for glory. But remember: Zing and bling demand a lot of ka-ching.



◀ FALCON NORTHWEST MACH V

Looking like an '84 Camaro, our Mach V came in deep purple, though Falcon Northwest will coat it in any tint. The Nvidia GeForce 6800 Ultra graphics card is boss, but the 3.6-GHz Intel Pentium 4 limited onscreen action to 132 frames per second in *Unreal* and 53 fps in *Far Cry* at 1,280 x 1,024 resolution – fast, but not fast enough for the price.

\$5,207, www.falcon-nw.com



↑ WIRED

Sweet paint job. Sports Nvidia's fastest graphics card.

↓ TIRED

Pentium 4 not so hot for gaming. (Request a 64-bit Athlon instead.) For the price of this hot rod, you could make a down payment on an actual car.



◀ VELOCITY MICRO RAPTOR 64 SPECIAL EDITION

For top speed, this is your flyboy. With the latest 64-bit AMD chip and Nvidia GeForce 6800 Ultra graphics card, it screamed through kill after kill in *Unreal*, flipping 180 fps at 1,280 x 1,024 – far outpacing the others. The single small exhaust fan made us worry about processor meltdown, though things stayed cool in our tests.

\$4,029, www.velocitymicro.com



↑ WIRED

Top-of-the-line components. Temperature gauge and adjustable fan. Available in several vivid colors.

↓ TIRED

Cheap-o case. Pressing fan button causes flimsy front panel to bow in, sometimes switching off power.



◀ VOODOO RAGE

The Rage's aluminum case is anodized black as night and the guts tinted bloodred. It features a 2.4-GHz, 64-bit AMD chip like the Raptor 64, but with half the cache buffer. The Nvidia GeForce 6800 GT card, though not top of the line, still raced Voodoo's box into second place in our ratings, churning 58 fps in *Far Cry* to the Velocity's 65 fps, and 155 fps in *Unreal* (with both games set to 1,280 x 1,024). The best number of all? The price.

\$3,845, www.voodooopc.com



↑ WIRED

Serious speed and performance inside a dark and scary (but beautiful and quiet) package. Less than \$4,000.

↓ TIRED

Slowish 8X DVD burner. Less hard drive space than rivals.

QUICK TIP

Any graphics card will do for everyday tasks. But for gaming, get the most powerful one you can afford.

Media Center PCs

Machines designed for Microsoft's entertainment OS run standard apps and let you record TV, retouch photos, and stream movies – all by remote control.



◀ HP m1050Y

This **living room** photomat has a cradle on top for an HP camera, and it integrates HP's image software into Media Center's menus, so you can edit pics through the remote. The 3.2-GHz Pentium 4 performed admirably, and the removable second hard drive made our photo libraries mobile.

\$1,655, www.hp.com



↑ WIRED

Front-mounted USB 2.0 and FireWire ports and A/V jacks. FM tuner. Dual-layer DVD+R/RW drive.

↓ TIRED

Occasional fan buzz when the CPU gets hot. Poky optical drives slowed down CD ripping.



◀ SHUTTLE ST61G4

The **toaster oven-sized** ST61G4 fits anywhere, but it's too stylin' to hide. The 3-GHz Pentium 4 processor, 512 megs of RAM, and 160-Gbyte hard drive are good for recording standard TV and playing videos and music. For intense media editing, though, you'll want a faster CPU.

\$1,309, www.shuttle.com



↑ WIRED

Nice balance of power and price. Wireless keyboard and mouse. Ripped CDs faster than the others.

↓ TIRED

Noisy fans. Wimpy graphics but no slot for an upgrade card.



◀ SONY RA810G

This **water-cooled** tower is whisper-quiet for TV time. And it silenced the competition in our media tests, converting a 255-Mbyte AVI clip into an MPEG-2 in 6 minutes, 33 seconds, and squishing a 110-Mbyte Photoshop file into a 7.5-Mbyte GIF in 5 seconds. If you've got the scratch, Sony's Media Center PC is the one to get.

\$2,200, www.sonymstyle.com







↑ WIRED

Fast and nearly silent. Dual-layer DVD burner does DVD+R/RW and DVD-R/RW formats. Honking 250-Gbyte hard drive for media.

↓ TIRED

Channel buttons on remote are poorly positioned.

Specialty PCs How We Tested

ALL SYSTEMS	CD RIPPING	IMAGE CONVERSION
	 <p>We had each machine encode Mos Def's <i>Black on Both Sides</i> to 128-Kbps AAC music files using Apple iTunes.</p>	 <p>A monstrous 110-Mbyte Photoshop file was compressed into a 7.5-Mbyte GIF using Adobe Photoshop CS.</p>
GAMING	GRAPHICS PERFORMANCE	VIDEO CONVERSION
	 <p><i>Unreal Tournament 2004</i> and <i>Far Cry</i> were used to measure frame rates at resolutions of 1,024 x 768, 1,280 x 1,024, and 1,600 x 1,200.</p>	 <p>We used Adobe Premiere Pro 1.5 to convert a 255-Mbyte AVI file downloaded from a camcorder to an MPEG-2 for burning onto a DVD.</p>

Additional testing by Alexandra Krasne.



Everything, Everywhere, Now!

Welcome to Media Center 2005, your total entertainment network.



The first Media Center PCs were little more than overblown DVRs. They handled your TV shows fine, but your music and photo collections were marooned on your hard drive. The 2005 version of Microsoft's Media Center operating system not only makes nice with your television and stereo, it turns your computer into the hub of a house-wide entertainment network.

The new edition's great leap forward comes in the form of support for third-party Media Center Extenders, relay boxes that connect to your A/V components and

stream real-time or recorded shows, photos, video, and music from your PC via Ethernet or Wi-Fi. (For more on Media Center Extenders, see page 152.) Another plus: Multiple tuner cards, including hi-def models, will endow a single Media Center PC with the recording and playback capabilities of an army of DVRs, capturing a number of shows on a number of channels while serving up saved programming to televisions throughout the house.

Media Center 2005 also sets your digital content free. Using the Media Player 10 engine, it resizes archived TV and then transfers it, as well as music and photos, to Pocket PC handhelds and personal video players running Microsoft's new Portable Media Center OS.

Other updates include support for the 16:9 widescreen format and improved video scaling that, to our eyes, resulted in higher-quality playback of both live and recorded TV.

Microsoft's setup has its shortcomings. It doesn't allow remote scheduling over the Internet, unlike some DVRs. It decodes and records over-the-air HDTV only, so digital cable and satellite subscribers need not apply. And it turns out that Extenders cost more than many DVRs do after current rebates. Still, it puts the power of a PC in your living room — minus the big box. — **B.L.**

Specialty PCs Scorecard

	Rating	Model	Price	Processor	RAM	Graphics System	Hard Disk	Optical Drive
GAMING	4.5	✓ Voodoo Rage	\$3,845	2.4-GHz AMD Athlon 64 3800+	1 Gbyte	256-Mbyte Nvidia GeForce 6800 GT	Dual 74-Gbyte, 10,000-rpm SATA drives with RAID	8X DVD+R/RW and DVD-R/RW
	4	Velocity Micro Raptor 64 SE	\$4,029	2.4-GHz AMD Athlon 64 FX-53	1 Gbyte	256-Mbyte Nvidia GeForce 6800 Ultra	Dual 74-Gbyte, 10,000-rpm SATA drives with RAID; 200-Gbyte 7,200-rpm SATA	12X DVD+R/RW and DVD-R/RW, 52X CD-RW
	3	Falcon Northwest Mach V	\$5,207	3.6-GHz Intel Pentium 4	1 Gbyte	256-Mbyte Nvidia GeForce 6800 Ultra	Dual 74-Gbyte, 10,000-rpm SATA drives with RAID; 250-Gbyte 7,200-rpm SATA	12X DVD+R/RW and DVD-R/RW, 16X DVD-ROM
MEDIA CENTER	5	✓ Sony RA810G	\$2,200	3.4-GHz Intel Pentium 4	1 Gbyte	128-Mbyte ATI Radeon X600	250-Gbyte, 7,200-rpm SATA	8X dual-layer DVD+R/RW and DVD-R/RW, 16X DVD-ROM
	4	HP m1050Y	\$1,655	3.2-GHz Intel Pentium 4	1 Gbyte	128-Mbyte ATI Radeon X300	250-Gbyte, 7,200-rpm SATA; removable 160-Gbyte 7,200-rpm drive	8X dual-layer DVD+R/RW, 16X DVD-ROM
	3	Shuttle ST61G4	\$1,309	3-GHz Intel Pentium 4	512 Mbytes	ATI Integrated Graphics (using main system RAM)	160-Gbyte, 7,200-rpm parallel ATA	8X DVD+R/RW and DVD-R/RW

Wireless Desktop Sets

The coolest keyboards and mouses use Bluetooth or RF technology to reduce cable clutter and add a little freedom to your home office. — Owen W. Linzmayer

MICROSOFT WIRELESS OPTICAL DESKTOP COMFORT EDITION

The curve in Microsoft's RF keyboard will help your wrists, but its protruding feet will cramp your lap-typing style. The board's layout includes 21 programmable buttons and a unique zoom slider for adjusting document magnification quickly. The ambidextrous mouse is comfortable.

\$85, www.microsoft.com



KENSINGTON COMFORT TYPE RECHARGEABLE

The Kensington's 20 silver function keys can be set to launch apps and enter keystroke combinations. The slightly slanted keys ease typing, and the RF range was twice as far as the stated 6-foot spec. Too bad it's incompatible with Apple computers and southpaws.

\$80, www.kensington.com



LOGITECH DINOVO MEDIA DESKTOP SHOWN

If chic electronics manufacturer Bang & Olufsen were to make a keyboard, it would be hard-pressed to top the diNovo's understated elegance (or its overblown price). The thin, light keyboard is a joy to behold as well as type on. The separate MediaPad, which is included, has a built-in LCD and serves as a calculator, keypad, and controller for Windows applications. Sculpted for righties, the MX 900 Cordless Optical Mouse rapidly recharges in its base station, which also adds Bluetooth capabilities to your PC.

\$250, www.logitech.com





USB Gadgets

"No port left behind." That appears to be the mantra of device makers cranking out bizarre plug-ins for your PC's vacant USB slots. – Owen W. Linzmayer

BODELIN TECHNOLOGIES COMPLETE PROSCOPE PACKAGE SHOWN

Play *Quincy* and examine evidence from your imaginary crime scene with this handheld electronic scope. View the microcosmos through the eyepiece or in full color on your monitor. The kit includes four lenses and an adapter to wire your analog microscope or telescope for digital observation.

\$765, www.theproscope.com



USB BLAST R-1000

Plug a telephone headset into the R-1000 to make digital recordings of calls, or use the built-in mike to capture sounds in the room. We pined for Mac support and dialing capabilities, but the real bumner is its dubious legal status: The gizmo may violate some states' wiretapping laws.

\$149, www.usblast.com



KEYSPAN K-ZIP-CELL-ER

Keyspan's compact chargers draw power from your PC to replenish phones from Kyocera, LG, Motorola, Nokia, Samsung, Sanyo, Siemens, or Sony Ericsson. Use the retractable 30-inch cable to refill your battery in about an hour.

\$22-30, www.keyspan.com



ADDLOGIX BEVERAGE WARMER

Hate it when your coffee gets cold as you IM late into the night? Unfortunately, this USB heating jacket won't help – it can't even keep spit warm. At least the kids will have fun wearing Addlogix's Velcro sleeve like a blood pressure cuff.

\$16, www.addlogix.com



CAREN ALPERT; STYLING BY DARLENE BULL/KORCORAN PRESENTS

COMPUTING AND GAMING

Gaming Accessories

There's no shame in playing videogames every day for hours and hours, unless you do it with lousy equipment.

by Todd Zuniga

142 **Gaming Speaker Systems**

143 **Wireless Controllers**

145 **Specialty Gear**

PLUS:

147 **Karaoke Mikes**





Gaming Accessories Essentials

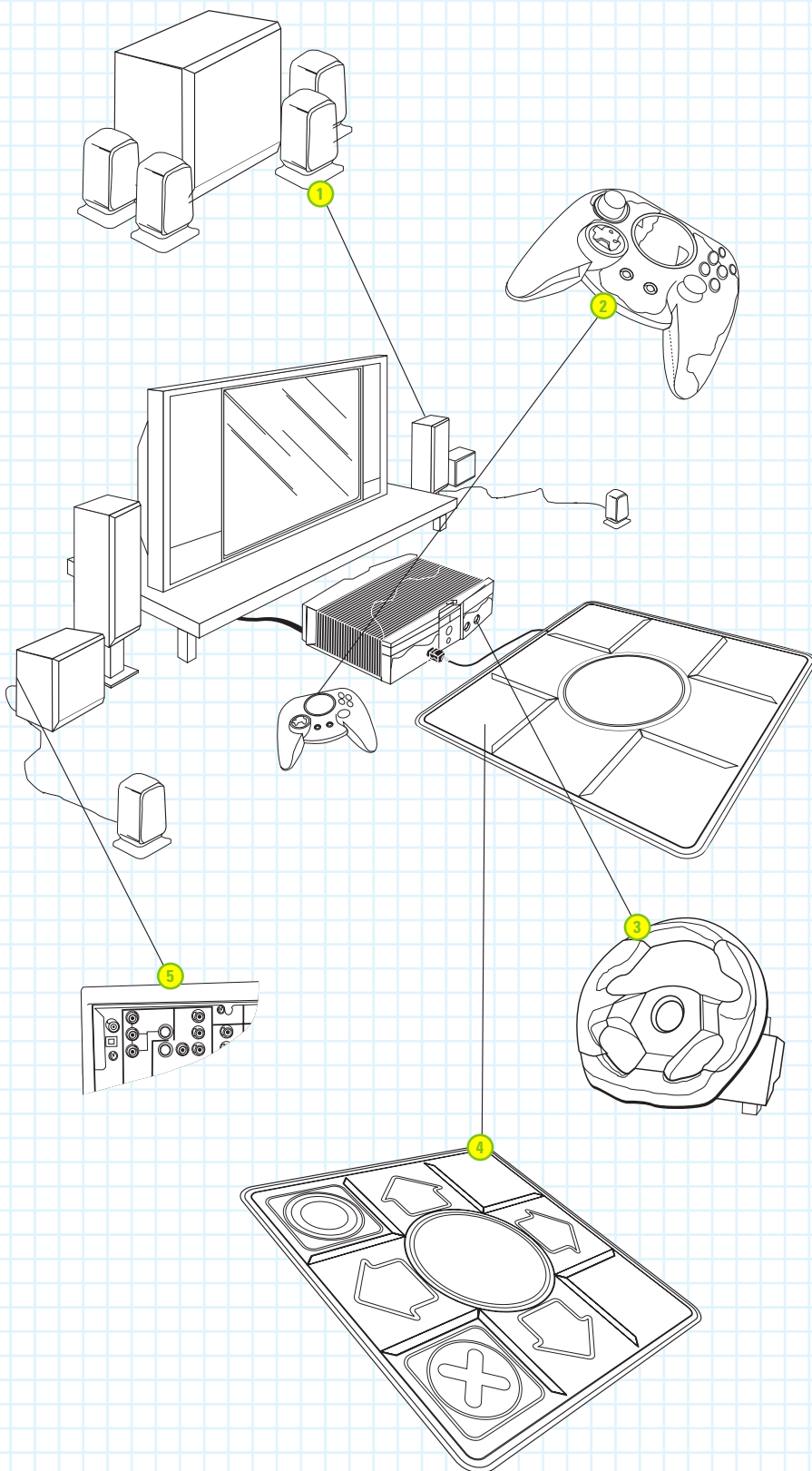

1 SURROUND SOUND

Get a setup with true 5.1 Dolby Digital and DTS capability. (THX certification for games is an added bonus.) It's hit or miss which games support DTS, but all DVD movies do, so it's worth the extra coinage. Beware: Some systems deliver only pseudo-surround, which pales in comparison.

2 WIRELESS CONTROLLERS

Check for these baseline specs: 2.4 GHz, 50 hours of battery life, and a 40-foot range. What separates the also-rans from the must-haves is comfort and touch. Where's the joy in being untethered if your fingers ache after 30 minutes of play?

3 DRIVING WHEELS

Steer clear of the cheap stuff. Top products are durable and have clamps, not suction cups, for solid mounting to desks or coffee tables. The best have a 900-degree turning radius.

4 DANCE PADS

If you have wood or other hard flooring, look for a pad that'll grip the surface well. On-pad menu navigation is a plus so you don't have to stop the body rock to restart the game.

5 AUDIO INPUTS

Make your gaming speaker system double as a multimedia sound hub by getting one with plenty of inputs for computers, MP3 devices, and DVD and CD players.

Gaming Speaker Systems

Pistol pops, bass-heavy soundtracks, helmet-denting tackles – today's games roll plenty of audio thunder. These 5.1 systems put you in the thick of it.



◀◀ KLIPSCH GMX D-5.1

Klipsch delivers on its rep with this powerful set. The subwoofer gives plenty of growl, and the system supports Dolby Digital for movies and games. But it won't decode DTS, which delivers more clarity and dynamics than Dolby's standard. And the control panel has an identity crisis: If it's for PC gamers, where's the headphone jack? If it's for console bangers, where's the remote?

\$199, www.klipsch.com



↑ WIRED

Satellite stands swivel to direct the sound where you want it. Nice price compared to the competition.

↓ TIRED

Looks and feels dated. Controls are clumsy to use. High-frequency audio sounds glassy.



◀◀ LOGITECH Z-5500 DIGITAL

With a hefty 10-inch subwoofer, the Z-5500 drops the biggest boom of the systems we reviewed. It also has the only center channel designed to be placed on a TV or monitor. It decodes both DTS and Dolby Digital, and the elegant control module has six inputs for plugging in your stereo, DVD player, and game boxes.

\$400, www.logitech.com



↑ WIRED

Analog and multiple digital inputs cover all sound needs. Satellite speakers have rotating pedestals for wall mounting.

↓ TIRED

Honkin' subwoofer is tough to hide. Ugly remote.



◀◀ SONY 5.1 SRS-D5100

Sony's glossy PC sound system includes a silver subwoofer that handles music, movies, and games equally well. But it doesn't do Dolby Digital or DTS, and the front speakers distort when big bangs are cranked to the max. If you're OK with plain old loud, however, this Sony system will fill the room with above-average audio.

\$230, www.sonymstyle.com



↑ WIRED

Easy on the eyes. Satellite braces can be positioned at rear for mounting speakers to the wall. Secondary input on control panel.

↓ TIRED

The 6-foot power cord is a bit short. Control knobs positioned too closely together.



◀◀ SPHEREX XBOX 5.1

Spherex's debut offering looks like a cluster of incubating pods from *Alien*. It works with all hardware – not just the Xbox – and its so-called omnipolar dispersion technology really does spread sound around the room for 360-degree envelopment. A USB port in the sub allows you to transfer bug fixes and new (as yet unnamed) features from your PC.

\$499, www.spherexinc.com



↑ WIRED

Handles DTS and Dolby Digital surround. Slick remote. Two optical and one coaxial input for digital sources, plus USB port.

↓ TIRED

Most expensive multimedia speakers reviewed. Subwoofer is a bit weaker than Logitech's.



Wireless Controllers

Leashes are for walking your pooch, not playing *Soul Calibur II* head-to-head. Get into the action – and out of the tangles – with a lightweight tether killer.



◀ HIP GEAR 2.4 GHZ (XBOX)

Microsoft's Xbox Controller S was a smart update to the original's clunky design, but it left the cable intact. Hip Gear tries to remedy this with a wireless version that nicely matches the Xbox look. The 2.4-GHz model has a buttery-smooth thumb pad, but stiff buttons and nearly a pound of heft weigh it down. It doesn't top the S, but it does let you roam. **\$30, www.hipgearproducts.com**



↑ WIRED

Macro feature saves sets of button presses – great for fighting games.

↓ TIRED

Old-fashioned Turbo button is a throw-in of little use with most current games.



◀ INTEC MINI (PS2)

The Mini has great battery life and the smoothest digital pad we tested. But its petite analog sticks and stiff buttons can leave your hands stinging after even a short session of *SOCOM 2*. Another glitch: Placement of Start and Select buttons could cause a mispress when you're desperate for a time-out. **\$30, www.intelink.com**



↑ WIRED

Batteries last a whopping 70 hours (with rumble off).

↓ TIRED

Three rumble settings sounds nice, but they feel weak. Includes the old, pointless Turbo button.



◀ LOGITECH CORDLESS ACTION CONTROLLER (PS2)

Logitech's latest wires-free unit is a total lightweight, in the best sense. The sleekest of the wireless bunch, it's a cinch to install – you don't even have to program the wireless channels on the controller and receiver. Its 30-foot range suffers from nary a hiccup. Best of all, the design closely mimics the unique look of Sony's Dual Shock 2 cord-bound controller. **\$40, www.logitech.com**



↑ WIRED

Autoselects channels when using multiple controllers. Battery lasts 50 hours with rumble, 100 without.

↓ TIRED

Shoulder buttons lack contour, making them slippery and hard to locate by feel.



◀ MAD CATZ LYNX (XBOX)

The Lynx was a bust right out of the box. The battery indicator light cover fell off almost immediately. Then, after we pried open the battery flap – no easy task – excessive force was required to cram the three AAs into place. We finally got the thing running only to find the triggers creaky. We shudder to think what else could go wrong after a few months of abuse. **\$30, www.madcatz.com**



↑ WIRED

Nice and compact – too bad about everything else.

↓ TIRED

Astonishing crapsmanship. Good luck replacing batteries without a hammer. Costs as much as Hip Gear's far better controller.



◀ NINTENDO WAVEBIRD (GAMECUBE)

Microsoft's latest Xbox pad feels comfy, and Sony's Dual Shock 2 is often lauded as a design masterpiece. But neither can match Nintendo's lightweight, well-shaped GameCube controllers with their ideal button and stick placement. The only first-party wireless on the market doesn't have rumble, but it's got everything else.

\$35, www.nintendo.com



↑ WIRED

Only \$10 more than the GameCube corded controller – and just as light and balanced.

↓ TIRED

No rumble could be a factor for a few games, like *Zelda: Wind Waker*. The fading GameCube needs more titles to justify buying additional gear for it.



◀ NYKO AIR FLO (PS2)

The Nyko's one trick is a mechanism that blows cooling air through holes in the grips. If your hands drip with sweat during heated matchups, this should help. But in all other respects, the Air Flo simply blows. It's bulkier than the competition, and the analog sticks and thumb pad are hypersensitive. (Menu navigation requires surgical precision.) The right stick interferes with button presses.

\$40, www.nyko.com



↑ WIRED

Innovative concept for the sweaty-palm set. Adjustable fan speed. Batteries last up to 40 hours, even with the fan on high.

↓ TIRED

Heavy, enormous controller requires four AA batteries. Design doesn't match the PS2. Blown air sometimes smells funky.

Your Xbox Ticket to Killer Abs

A screen obsession to make you fitter, not fatter.

If your workout consists of leaving the couch to turn on your Xbox and play *Madden NFL 2005* a dozen times until the pizza guy arrives, you might rethink your exercise routine. For starters, try responDesign's *Yourself!Fitness* for Xbox. More experience than game, this title turns you into the peripheral, walking you through crunches and squats onscreen to tone your bod in real life. While you'll need the controller occasionally to navigate menus, you'll mostly be in the capable hands of your polygonal personal trainer, Maya.

She starts by asking you to select health and fitness goals. Then she leads you through reps and sets of routines in aerobics, pilates, strength training, yoga, and guided meditation. She provides step-by-step instruction on a total of 400 unique exercises, from warm-up to power off.

Each day, Maya personalizes your routine based on your progress and commitment level. So if you're worn out from an all-night *Halo 2* session, she'll kindly slow things down. And don't sweat sacrificing your gaming fund to buy newfangled gym equipment. Maya integrates whatever you already have – just dust off the cobwebs from your sand-filled dumbbells.

Since stuffing yourself with McDonald's post-workout won't fly, you use the *Yourself!Fitness*' meal planner for healthy dining. Maya chimes in with nutritional advice and doles out more than 4,500 recipes, preparation instructions, and even shopping lists.

\$35, www.yourselffitness.com





Specialty Gear

Whether you're a disco freak, a would-be assassin, or the next Nascar sensation, these gaming extras take virtual reality beyond the screen and into your hands, feet, and backside.



◀◀ COBALT FLUX DANCE PAD

Don't worry if you get down like Elaine on *Seinfeld*. Cobalt Flux created this pricey dance pad so you can practice your ankle-spraining moves in private. Problem is, it slides on uncarpeted surfaces, and stomping the pads makes quite the racket. Newbies are liable to lose the beat – there's little in the way of guides for your two left feet.

\$299, www.cobaltflux.com



↑ WIRED

Sturdy. Triangle button on the mat makes menu navigation easier than the waltz. Buy two and score a free attachment for linking them.

↓ TIRED

Expensive. Xbox owners need an adapter.



◀◀ REDOCTANE METAL PAD

RedOctane's system turns your gaming room into a *Saturday Night Fever* disco. Silver and sleek, this metal pad is worth the cost if you're serious about your vid boogie. Too bad it relies on an external control box for navigating the menus instead of using the pad's rear area for embedded controls. Mirror ball not included.

\$200, www.redoctane.com



↑ WIRED

Best pad for the price. Foam bottom stays put on any surface. Multi-platform hookups out of the box. Bolts on pad help guide beginners.

↓ TIRED

Rear and center square stickers started peeling off after only a few hours of dancing.



◀◀ INTEC WIRELESS RACING WHEEL

Intec's wireless Xbox wheel drove us up the wall. The interface will baffle experienced drivers, and the suction pads on the base made it wobbly and hard to control. There's little to love about this plastic rig, except perhaps the ease with which you can toss it aside and not trip over a wire.

\$80, www.inteclink.com



↑ WIRED

No response lag.

↓ TIRED

Rumble is weak and clunky. Wheel grips cause slippage in tight races. Does everything in its power to keep you from turning.



◀◀ LOGITECH DRIVING FORCE PRO

The greatest thing to happen to driving games since *Gran Turismo 3*, this wheel feels like it was lifted from a rally car. The force feedback lets you feel every bump on even the smoothest virtual roads. Best of all, it has a 900-degree turning radius, so you can spin out in games like *GT4*.

\$150, www.logitech.com



↑ WIRED

Must-buy for racing game fans. Rubber grips add to the realism.

↓ TIRED

Hard to use unless you clamp it to a table. Pedals slip on hard surfaces. Short power cord.



◀ **GUITAMMER BUTTKICKER GAMER**

Attach the device to a standard office chair, then ride the rumble. By delivering a game's low-end frequencies right to your backside, the ButtKicker box shakes things up without knocking down your neighbor's wall hangings. Remember to quiet the game's music, or every bass line will give you a jolt. **\$150, www.thebuttkicker.com**



↑ **WIRED**

Feel kickback every time you fire in a first-person shooter.

↓ **TIRED**

Attaches only to chairs with a center post – not intended for your Barcalounger. Responds to all bass, meaning gunshots and music give the same thump.



◀ **MONSTERGEEKO PISTOLMOUSE FPS**

If you're not feeling rattled enough while butchering the Axis in *Battlefield 1942*, park this gun-shaped optical mouse on your desk for that extra shot of authenticity. It has good balance and a solid-feeling trigger. Warning: You'll feel ridiculous navigating your online photo album with a monster gat. **\$70, www.monstergecko.com**



↑ **WIRED**

Eye-catching. Durable. Scroll wheel is easy to access with the thumb.

↓ **TIRED**

Vets will have a hard time giving up a conventional mouse. Must stay on desktop for optical sensor to work, so no waving it around.

Gaming Accessories Scorecard

	Rating	Model	System	Price	Total Watts	Inputs
GAMING SPEAKER SYSTEMS	4.5	Logitech Z-5500 Digital	All	\$400	500	Optical, coaxial, 4 stereo mini audio
	4	Spherex Xbox 5.1	All	\$499	300	Optical, coaxial, stereo mini audio; USB
	3	Klipsch GMX D-5.1	All	\$199	100	Optical, coaxial, RCA audio
	1.5	Sony 5.1 SRS-D5100	PC	\$230	140	Stereo mini

	Rating	Model	Price	Other Console Versions Available	Rated Battery Life	Range
WIRELESS CONTROLLERS	5	Logitech Cordless Action Controller (PS2)	\$40	Xbox	50 hours	30 feet
	4	Nintendo WaveBird (GameCube)	\$35	None	100 hours	20 feet
	3	Hip Gear 2.4 GHz (Xbox)	\$30	GameCube PS2	100 hours	50 feet
	3	Intec Mini (PS2)	\$30	GameCube, Xbox	70 hours	30 feet
	2	Nyko Air Flo (PS2)	\$40	GameCube, Xbox	40 hours	50 feet
	1	Mad Catz Lynx (Xbox)	\$30	PS1, PS2	60 hours	40 feet

	Rating	Model	System	Price	Best Played With	Additional Features
SPECIALTY GEAR	4.5	Logitech Driving Force Pro	PS2	\$150	<i>Gran Turismo 4</i>	900-degree turning radius
	4	MonsterGecko PistolMouse FPS	PC, Mac	\$70	<i>Battlefield 1942</i>	Can be used as a regular mouse
	4	RedOctane Metal Pad	PS1, PS2, Xbox	\$200	<i>Dance Dance Revolution Ultramix</i>	On-pad menu-navigation controls
	3	Cobalt Flux Dance Pad	PS1, PS2	\$299	<i>Dance Dance Revolution Extreme</i>	Can link with other Cobalt dance pads
	2	Guitammer ButtKicker Gamer	All	\$150	<i>Halo 2</i>	None
	1	Intec Wireless Racing Wheel	Xbox	\$80	<i>Burnout 3: Takedown</i>	Adjustable sensitivity



Karaoke Mikes

Sing it loud! These portable party machines are packed with hundreds of songs and provide onscreen lyrics. Earplugs for neighbors sold separately. – Brian Lam

LEADSINGER LS-3000 SHOWN

Leadsinger pumps up the jams with the most abundant catalog of expansion chips, each featuring 100 to 200 songs. Its performance evaluator rates your tonal accuracy. When we fortified the playlist with all 15 English language additions (at \$70 to \$90 apiece), it outlasted our voices. Too bad you need to be a rock star to afford the complete library.

\$130, www.leadsinger.com



KORITECH HANDY STAR

Koritech's MIDI synthesizer reproduces backing tracks that sound more like music than Muzak. The built-in library of 2,000-plus tunes seems generous – until you realize that half are in Tagalog. But the 1,000 tunes in English provided enough quality material for four hours of showboating.

\$349, www.dtskaraoke.com



ENTER TECH MAGIC SING-ALONG V

With more than 700 built-in songs – and another 1,500 available on 11 expansion chips – the Enter Tech offers plenty of A-list choices for revelers. You can even record performances for posterity (or extortion). The forgiving onscreen scoring flattered even the most off-key rebel yeller. A wireless second mike is available.

\$329, www.acekaraoke.com



COMPUTING AND GAMING

Media Streamers

Ditch that task chair and stretch out on the couch. Streamers deliver digital music and video to your living room.

by Owen W. Linzmayer

150

Audio Streamers

152

Audio/Video Streamers



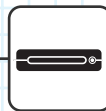

Media Streamer Essentials

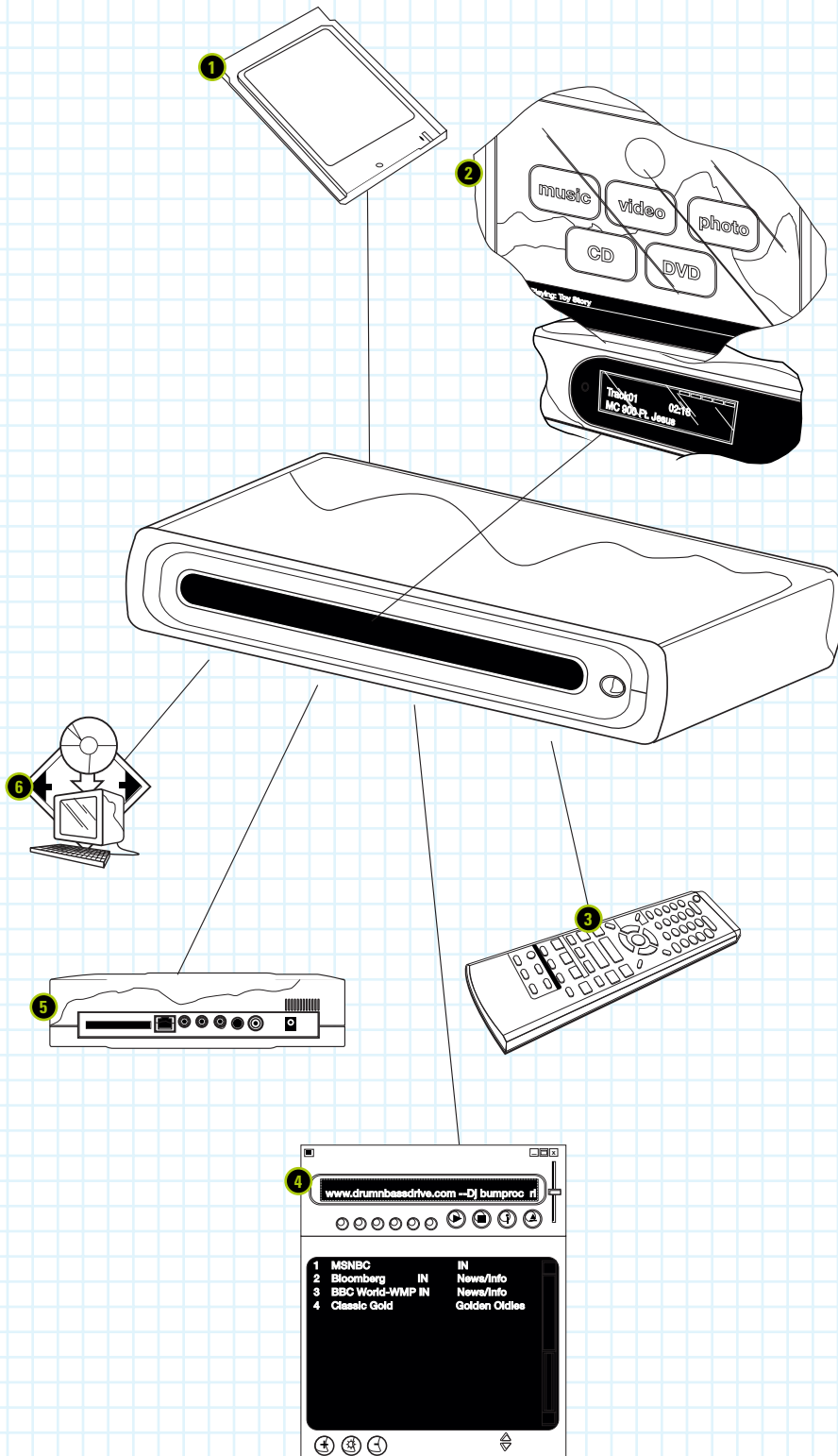

1 WIRELESS STANDARD
Basic 802.11b Wi-Fi is speedy enough for audio, but you'll want a faster 802.11g or 802.11a network to ensure smooth video.

2 DISPLAY
On audio streamers, a good screen is critical for browsing through thousands of songs. Fluorescent displays are easy to read from across a room; small LCDs usually aren't. Audio/video streamers use your TV's screen for better legibility.

3 REMOTE CONTROL
Every unit except Apple's AirPort Express includes a remote, but not all remotes are created equal. Look for one that controls volume and has large, clearly labeled buttons arranged in an intuitive layout.

4 INTERNET RADIO
Most streamers that handle Net radio work with stations that broadcast in MP3 format (no Windows Media or RealAudio support yet) and come with presets for hundreds of stations organized by genre.

5 SERVER SOFTWARE
Almost all streamers require your computer to run server software — usually a proprietary app. A few streamers can, in theory, access any computer running music-organizing programs, like Musicmatch, that support the universal plug-and-play (UPnP) standard.

6 OUTPUTS
All media streamers have basic analog outputs. Look for players that include higher-quality options, like digital audio via optical or coaxial ports and video via S-video or component connections.

Audio Streamers

Tunes flow nicely over Wi-Fi, and these music wranglers mine your digital collection and the Internet to give you access to enough songs for a lifetime of listening.



◀ APPLE AIRPORT EXPRESS

The **extremely compact** AirPort Express can serve as a music streamer, a wireless link for USB printers, even a wireless network hub. Audio is controlled from your computer through iTunes, which is a great interface, but it's inconvenient if your audio gear is in a different room. For that, we'd like a remote with a built-in display.

\$129, www.apple.com



↑ WIRED

Remarkably affordable. Cross-platform compatibility. Only device that plays iTunes Music Store's protected AAC files.

↓ TIRED

Audio cables not included (\$39 for kit). No remote or display.



◀ CREATIVE SOUND BLASTER WIRELESS MUSIC

Like the AirPort Express, Creative's receiver lacks a display. But it comes with a big, bright LCD on the best remote in the test. Too bad the rest of the system is uninspiring. Its bare-bones hardware works with a trio of lackluster programs for managing only MP3 and WMA files.

\$200, www.creative.com



↑ WIRED

RF remote rocks with a large backlit display that lets you make choices from anywhere in its 32-foot range.

↓ TIRED

Supports just two audio formats. No Internet radio. Failed to read songs' ID3 tags properly.



◀ LINKSYS WIRELESS-B MUSIC SYSTEM

With Musicmatch Jukebox software, vTuner for Internet radio, and Rhapsody compatibility, this Linksys box offers plenty of content. But setting it up required a wired Ethernet connection and a tech support call to reset the hardware. And its powered speakers deliver weak sound.

\$180, www.linksys.com



↑ WIRED

Musicmatch beats many bundled server applications. Rhapsody and vTuner support.

↓ TIRED

Difficult setup. Disappointing sound quality. LCD nearly illegible unless viewed straight-on.



◀ MACSENSE HOMEPOD MP-100

We found little to like in this unreliable device. The built-in speakers sounded pathetic, music servers disappeared inexplicably from the menu, and MP3 files couldn't be found on a hard drive attached to the USB 1.1 port. Promised support for Mac OS 9 as well as AAC and WMA files is still MIA.

\$175, www.macsense.com



↑ WIRED

Works with Mac and Windows. Includes FM radio and USB port.

↓ TIRED

LCD is hard to read. Poor button placement on tiny remote results in inadvertent shutdowns and server resets. Packaging incorrectly claims support for Mac OS 9.

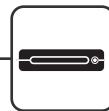

◀ NETGEAR MP101

The **boxy MP101** has all the charm of a police scanner, but it's packed with features, including seamless support for Rhapsody, vTuner Internet radio, and other universal plug-and-play server apps. Or you can use the proprietary Netgear Media Server software. It can import libraries or playlists from some music management programs, but not iTunes.

\$149, www.netgear.com



↑ WIRED

Affordable. Solid performer with good UPnP support.

↓ TIRED

Poor text display. Plays MP3 and WMA files only. Remote cluttered with tiny buttons, but none for volume. Lacks documentation for server software.



◀ ROKU SOUNDBRIDGE M1000

The **elegant SoundBridge** sports a generous 280 x 16-pixel, blue fluorescent display. It can access music on computers running either iTunes or the open source SlimServer software, and it comes with high-end digital outputs (analog, too). We especially like the Fast Browse feature for finding tracks in huge libraries.

\$250, www.rokulabs.com



↑ WIRED

First-class design actually looks good next to high-end audio equipment. Simple setup. Big, bright display.

↓ TIRED

Expensive. No Wi-Fi signal meter. Occasionally confusing interface.



◀ SLIM DEVICES SQUEEZEBOX

While the **Squeezebox** lacks the SoundBridge's visual appeal, it's a formidable streamer. The graphic screen and controller board offer a range of text sizes, pretty fonts, and smooth scrolling. Though the user docs are confusing, the device walks you through the easy setup. It effortlessly imports iTunes playlists and non-copy-protected tracks.

\$279, www.slimdevices.com



↑ WIRED

Clean styling. Great display. Supports most common audio file formats and works with Windows, Mac OS X, and Linux.

↓ TIRED

Pricy. Documentation is way too geek-centric.



◀ SMC NETWORKS SMCWAA-B

There's **no nice** way to say it: This product is a piece of crap. The AC adapter requires fiddling to get juice. Audio drops out frequently, even with decent Wi-Fi signal strength – something we didn't experience on any other streamer. And the unit often doesn't respond to the remote, which features small buttons with indecipherable, cutesy icons.

\$130, www.smc.com



↑ WIRED

Meters for buffer and wireless signal strength update in real time. Only streamer that lets you bookmark radio stations.

↓ TIRED

Fimsy construction. Minijack output only. No Ethernet port or power switch.

Audio/Video Streamers

Don't let your ears have all the fun. Get your eyes in on the action with boxes that stream photos, movies, home videos, *and* music from your computer.



◀ ICUBE PLAY@TV NMP-4000

Inexpensive doesn't have to mean cheap. This unit is solid, with a wealth of A/V connectors. The PC software is a bit confusing, but the TV-side interface is easy to navigate. Video playback is perfect; you can even switch between programs and set bookmarks within shows.

\$200, www.playatv.com



↑ WIRED

Smooth audio and video over 802.11b. Remote with volume control and one-button access to signal-strength meter.

↓ TIRED

Minimal printed documentation. No Internet radio.



◀ PHILIPS STREAMIUM SL400i

Don't pay a premium for the Streamium. While the Internet radio selection is extensive, the photo, video, and game functions seem like afterthoughts. The device doesn't even display album art when you're playing music. And you can't bookmark scenes in video.

\$449, www.streamium.com



↑ WIRED

Attractive design. Full range of outputs. Handles most common video formats.

↓ TIRED

Priciest unit tested. Dim LCD hard to read from the sofa. Only audio supported is MP3. Photos often cropped at edges.



◀ PRISMIQ MEDIAPLAYER

We plugged this black box in and it immediately found our Wi-Fi network and media files. Video playback over 802.11g is fine, and you can jump back and forth a user-determined number of seconds. Our main complaint: It's maddeningly hard to control the onscreen pointer with the remote.

\$200, www.prismiq.com



↑ WIRED

Great interface. Easiest setup. Optional \$30 wireless keyboard a good buy for built-in Web surfing and chat functions.

↓ TIRED

Rhapsody interface is different than the one for standard audio.

Media Center Extender

Microsoft's media PCs take over your whole house.

Microsoft wades into the streaming business in late 2004 with the introduction of Media Center Extender. If you've already bought – or you plan to buy – a Windows Media Center PC (see “Everything, Everywhere, Now!” page 137), you'll soon have a seamless way to integrate it with the rest of your home entertainment gear.

Using wired or wireless networks, Media Center Extender devices link your A/V equipment to your computer through the user-friendly Windows XP Media Center 2005 interface. According to Microsoft, a single Media Center PC can perform standard computing tasks while it simultaneously

streams content to up to five separate Extender boxes on the home network.

Alienware, Dell, Gateway, Hewlett-Packard, Samsung, and other hardware manufacturers have announced their intentions to release products – from stand-alone boxes to televisions – that will incorporate the Extender technology. Microsoft has even promised to release a Media Center Extender kit for the Xbox. Pricing hasn't been announced, but it's anticipated that the devices will sell for \$200 to \$300, making them competitive with other media streamers currently on the market. – O.W.L.

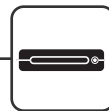

◀ SMC NETWORKS SMCWMR-AG

This **SMC wireless** receiver aims low and still disappoints. The hardware has the bare minimum of connectors, and its software feels unfinished, with a hostile interface. For example, it requires you to type in URLs for Internet radio and shows file paths instead of displaying MP3 track names and album art.

\$250, www.smc.com



↑ WIRED

Streams audio and video, but just barely.

↓ TIRED

Composite video jacks only. Wi-Fi configuration is tedious. Remote has tiny buttons and no volume control. No fast-forward or reverse functions for video playback.

Media Streamers Scorecard

	Rating	Model	Price	Formats Supported	Outputs	Wireless
AUDIO	5	✓ Roku SoundBridge M1000	\$250	MP3, AAC, WMA, Ogg Vorbis, AIFF, Apple Lossless, WAV audio	Optical, coaxial, RCA audio	802.11b
	4	Apple AirPort Express	\$129	MP3, AAC, WMA, AIFF, Apple Lossless, WAV audio	Combination analog and optical minijack audio	802.11b/g
	4	Slim Devices Squeezebox	\$279	MP3, AAC, WMA, Ogg Vorbis, FLAC, AIFF, Apple Lossless, WAV audio	Optical, coaxial, RCA, minijack audio	802.11b/g
	3	Netgear MP101	\$149	MP3, WMA audio	RCA, minijack audio	802.11b/g
	2	Creative Sound Blaster Wireless Music	\$200	MP3, WMA audio	Optical, RCA audio	802.11b/g
	2	Linksys Wireless-B Music System	\$180	MP3, WMA, WAV audio	Optical, RCA audio	802.11b
	1	Macsense HomePod MP-100	\$175	MP3 audio	Optical, coaxial, RCA, minijack audio	802.11b
	0.5	SMC Networks SMCWAA-B	\$130	MP3, WMA audio	Minijack audio	802.11b/g
AUDIO/VIDEO	5	✓ icube Play@TV NMP-4000	\$200	MP3, WMA, WAV audio; MPEG-1, MPEG-2, WMV, DivX, ASF, XVID video	Optical, RCA audio; component, S-video, composite video	802.11b (with card)
	4	Prismiq MediaPlayer	\$200	MP3, WMA, WAV audio; MPEG-1, MPEG-2, MPEG-4, DivX, AVI, Motion-JPEG, VOB video	Coaxial, RCA audio; S-video, composite video	802.11b/g (card not included)
	2	Philips Streamium SL400i	\$449	MP3 audio; MPEG-1, MPEG-2, MPEG-4, DivX video	Coaxial, RCA audio; component, S-video, composite video	802.11a/b/g
	1	SMC Networks SMCWMR-AG	\$250	MP3 audio; MPEG-1, MPEG-2, DivX video	RCA audio; composite video	802.11a/b/g

WIRED IS A REGISTERED TRADEMARK OF ADVANCE MAGAZINE PUBLISHERS INC., PUBLISHED THROUGH ITS DIVISION, THE CONDÉ NAST PUBLICATIONS. COPYRIGHT ©2004 THE CONDÉ NAST PUBLICATIONS. ALL RIGHTS RESERVED. PRINTED IN THE USA.

Wired (ISSN 1059-1028), November 2004, Volume 12, No. 11A. Wired is published monthly by The Condé Nast Publications, which is a division of Advance Magazine Publishers Inc. Editorial office: 520 Third Street, 3rd Floor, San Francisco, CA 94107-1815. Principal office: The Condé Nast Building, 4 Times Square, New York, NY 10036. Advance Magazine Publishers Inc.: S. I. Newhouse, Jr., Chairman; Steven T. Florio, Vice Chairman; Charles H. Townsend, COO; John W. Bellando, Executive Vice President and CFO; Jill Bright, Executive Vice President, Human Resources; John Buese, Executive Vice President, Chief Information Officer; Maurie Pearl, Senior Vice President, Chief Communications Officer; David Orlin, Senior Vice President, Strategic Sourcing; Robert Bennis, Senior Vice President, Real Estate. Shared Services provided by Advance Magazine Group: David B. Chemidlin, Senior Vice President, General Manager, Shared Services Center. Periodicals postage paid at New York, New York, and at additional mailing offices. Canadian Goods and Services Tax Registration No. R123242885.

POSTMASTER: Send address changes to Wired, PO Box 37706, Boone, IA 50037-0662. For subscriptions, address changes, adjustments, or back-issue inquiries: Write to Wired, PO Box 37706, Boone, IA 50037-0662; call +1 (800) 769 4733; or email subscriptions@wiredmag.com. Eight weeks are required for change of address. Please give both new and old address as printed on most recent label. First copy of new subscription will be mailed within eight weeks after receipt of order. Address all editorial, business, and production correspondence to Wired magazine, 4 Times Square, New York, NY 10036. For Permissions and Reprint requests, please call +1 (212) 286 8349 or fax requests to +1 (212) 286 8628. Visit us online: www.wired.com/wired. To subscribe to other Condé Nast magazines on the World Wide Web, visit www.condenet.com. Occasionally, we make our subscriber list available to carefully screened companies that offer products and services that we believe would interest our readers. If you do not want to receive these offers and/or information, please advise us at PO Box 37706, Boone, IA 50037-0662 or call +1 (800) 769 4733.

WIRED IS NOT RESPONSIBLE FOR LOSS, DAMAGE, OR ANY OTHER INJURY TO UNSOLICITED MANUSCRIPTS, UNSOLICITED ARTWORK (INCLUDING, BUT NOT LIMITED TO, DRAWINGS, PHOTOGRAPHS, OR TRANSPARENCIES), OR ANY OTHER UNSOLICITED MATERIALS. THOSE SUBMITTING MANUSCRIPTS, PHOTOGRAPHS, ARTWORK, OR OTHER MATERIALS FOR CONSIDERATION SHOULD NOT SEND ORIGINALS, UNLESS SPECIFICALLY REQUESTED TO DO SO BY WIRED IN WRITING. MANUSCRIPTS, PHOTOGRAPHS, AND OTHER MATERIALS SUBMITTED MUST BE ACCOMPANIED BY A SELF-ADDRESSED OVERNIGHT-DELIVERY RETURN ENVELOPE, POSTAGE PREPAID.



Erectile Dysfunction Pills

Kiss your performance anxiety good-bye with a little Barry White on the hi-fi and an erectile dysfunction pill in your nightstand drawer. – **Gordon Bass**

VIAGRA (SILDENAFIL CITRATE) 50 MG

Bob Dole's props to the blue pill give it undeniable, if inexplicable, cachet. Still, we were weirded out by an unnatural stiffness that lingered after the deed was done. Some users report tinted vision and the common ED-pill headache. The drug fades after four hours, so Tantrists and porn stars look elsewhere.

\$91 for 10, www.viagra.com



LEVITRA (VARDENAFIL HCL) 20 MG

With its five hours of staying power, Levitra packs the most punch for hard-to-treat cases of impotence. (Think diabetes.) Too bad it also inflicts a nasty headache for the duration. And if that doesn't turn you off, visions of spokesperson Mike Ditka should do the trick.

\$88 for 10, www.levitra.com



CIALIS (TADALAFIL) 20 MG SHOWN

Spring into action – and stay that way. Cialis takes effect within 15 minutes and keeps it humming for up to 36 hours, much longer than both Levitra and Viagra. Pop one Saturday night and you'll be up for a quickie Monday morning. No wonder the French dubbed it "le weekend" pill.

\$90 for 10, www.cialis.com

